

Baseline Technical and Economic Assessment of a Commercial Scale Fischer-Tropsch Liquids Facility

DOE/NETL-2007/1260



Final Report

April 9, 2007



Disclaimer

This report was prepared as an account of work sponsored by an agency of the United States Government. Neither the United States Government nor any agency thereof, nor any of their employees, makes any warranty, express or implied, or assumes any legal liability or responsibility for the accuracy, completeness, or usefulness of any information, apparatus, product, or process disclosed, or represents that its use would not infringe privately owned rights. Reference therein to any specific commercial product, process, or service by trade name, trademark, manufacturer, or otherwise does not necessarily constitute or imply its endorsement, recommendation, or favoring by the United States Government or any agency thereof. The views and opinions of authors expressed therein do not necessarily state or reflect those of the United States Government or any agency thereof.

Baseline Technical and Economic Assessment of a Commercial Scale Fischer-Tropsch Liquids Facility

DOE/NETL-2007/1260

Final Report for Subtask 41817.401.01.08.001

April 9, 2007

NETL Contact:

**Michael Reed
Senior Systems Analyst
Office of Systems Analyses and Planning**

Prepared by:

**Lawrence Van Bibber
Research & Development Solutions, LLC (RDS)/
Science Applications International Corp. (SAIC)**

**Erik Shuster
RDS/SAIC**

**John Haslbeck
RDS/Parsons**

**Michael Rutkowski
RDS/Parsons**

**Scott Olson
RDS/Nexant**

**Sheldon Kramer
RDS/Nexant**

**National Energy Technology Laboratory
www.netl.doe.gov**

BACKGROUND



Economic and national security concerns related to liquid fuels have revived national interest in alternative liquid fuel sources. Coal to Fischer-Tropsch fuels production has emerged as a major technology option for many states and the Department of Energy. This report summarizes the preliminary results of an NETL study to assess the feasibility of commercial scale, coal-to-liquids production using a high Btu Midwestern Coal.

Baseline Technical and Economic Assessment of a Commercial Scale Fischer-Tropsch Liquids Facility

EXECUTIVE SUMMARY

OVERVIEW

This report examines the technical and economic feasibility of a commercial 50,000 barrel per day (bbl/day) coal-to-liquids (CTL) facility in the Illinois coal basin. The facility employs gasification and Fischer-Tropsch (F-T) technology to produce commercial-grade diesel and naphtha liquids from medium-sulfur bituminous coal. The scope of the study includes conceptual design development, process analysis, component descriptions, capital and operating cost estimates, and a comparative financial analysis.

PLANT DESIGN

The plant design evaluated in this feasibility study incorporates coal gasification technology and an F-T reactor system using an iron-based catalyst. The concept includes a cluster of four gasification plants, each containing two gasifier trains for a total of eight gasifier trains. Clean syngas from the gasification plants is pooled and ducted to a central CTL plant. The CTL plant contains F-T reactors, hydrotreating units and hydrocracking units capable of producing 27,819 bbl/day of commercial-grade diesel liquid and 22,173 bbl/day of naphtha liquids, which could be shipped to a refinery for further upgrading into commercial-grade end products or for use as a feedstock for the chemicals industry. The CTL plant also generates electric power, both for internal use and for export to the grid. The plant design includes equipment to separate and compress carbon dioxide to 2200 psia for injection into a pipeline. Subsequent off-site use and/or sequestration of carbon dioxide are not considered in this design.

Figure ES-1 provides a block flow diagram of the F-T plant. The analysis is based on Illinois No. 6 bituminous coal and ConocoPhillips' E-GasTM gasification technology. The gasifier features a two-stage, oxygen-blown, entrained flow, refractory-lined gasifier with continuous slag removal. A dedicated air separation unit supplies 95 mole % purity oxygen to the gasifiers. Syngas leaving the gasifier is cooled in a fire tube syngas cooler, producing high-pressure steam, and then directed to a water scrubber to remove particulates and trace components. The resulting syngas stream is reheated and sent to a packed bed hydrolysis reactor, in which carbonyl sulfide (COS) and hydrogen cyanide (HCN) are converted to hydrogen sulfide (H₂S). A mercury removal system, consisting of a packed bed of sulfur impregnated activated carbon, removes mercury, arsenic and other trace materials from the syngas stream, while a dual-stage Selexol unit sequentially removes H₂S and CO₂ from the cool, particulate-free gas stream.

The clean syngas is then sent to the Fischer-Tropsch slurry reactors to produce marketable hydrocarbon liquids. Because syngas conversion is less than 100% per pass

in the F-T reactors, the incoming syngas is mixed with recycled gas to maximize liquids production.

In the F-T unit's distillation column, the liquid product is separated into light components, naphtha, distillate, and wax fractions for further processing.

The off-gas from the F-T process is compressed and used as fuel for the gas turbines, GE 6FA units that produce a total of 251 MWe. Unburned fuel remaining in the turbine exhaust is combusted in a downstream duct burner. Hot flue gas from the gas turbine passes through a heat recovery steam generator to produce superheated high-pressure steam. The resulting steam is combined with that produced by cooling the syngas in the gasification train and with that generated by recovering heat from the F-T reactors and expanded in a multi-stage steam turbine to generate an additional 401 MWe. Auxiliary plant loads consume the majority of the generated power, leaving a net 124 MWe available for export to the grid.

The naphtha fraction from the distillation column is sent to a catalytic hydrotreating unit for processing into naphtha products. The distillate and wax fractions are sent to catalytic hydrotreating units for processing into distillate. The combined distillate stream is blended with the required additives to produce a marketable diesel fuel. The naphtha and diesel liquids are shipped off-site either by rail tanker cars or barges.

Total plant performance data is summarized in Table ES-1.

Table ES-2 Total Plant Costs (\$millions)

Coal & Slurry Preparation	295
Gasifier & Gas Clean-up	1,978
F-T Process	705
Power Block	237
Balance of Plant	435
TPC	3,650

For use in the financial analysis, the TPC estimate has to be increased to account for working capital, start-up costs and owners' costs; this brings the total cost to \$4,070 million. The addition of financing costs during construction raises total project costs to \$4,528 million or \$90,574 per barrel of product per day.

Operations and maintenance cost values were determined on a first-year basis and then applied over the 20-year plant life. Operation costs were calculated on the basis of the number of operators, and maintenance costs on the basis of requirements for each major plant section. First-year operations and maintenance (O&M) estimates are \$201.2 million for fixed O&M and \$13.1 million for variable O&M, which includes credits for sale of by-products, sulfur and power.

The financial analysis was performed using the NETL Power Systems Financial Model, Version 5.0.5. Assumptions include a 26% project contingency applied across the CTL plant, a 25% process contingency applied to the F-T liquids portion of the plant, and a CTL plant capacity factor of 85%. Additional assumptions include a 40% tax rate, a 42-month construction period, a 30-year plant life, a 55:45 debt-to-equity ratio for project financing, a 3% annual price escalation on all plant outputs, and a 2% annual escalation in the price of coal.

The financial analysis provides key metrics against which to gauge project viability, including return on equity investment (ROI), net present value, and parameter sensitivities. Table ES-3 summarizes the results of the financial analysis under baseline financial conditions, which yields an ROI of almost 20%.

Table ES-3 Financial Analysis Results

Parameter	Base Case
Return on Investment, %	19.8
Net Present Value, \$MM, 12% discount rate	1,543
Payback Period, years	5

The financial analysis also included a sensitivity analysis to identify the parameters with the greatest impact on ROI, using a $\pm 25\%$ change in the input value as the basis for variable comparison. All model inputs were varied except for coal feed rate and liquid product output rate. The range of model input variables used in the sensitivity analysis is listed in Table ES-4. The “tornado diagram” shown in Figure ES-2 ranks the variables from highest to lowest in terms of their relative impact on ROI. Plant capacity factor and capital cost (“EPC cost”) have a very strong impact on ROI. This is a common sensitivity found in gasification studies; reliable plant operation and carefully controlled plant costs are critically important to a successful project. For example, if plant capacity factor were to fall from its base case value of 85% to a value of 60%, the plant ROI would decline from 19.8% to about 15%.

The estimated market values for the F-T products, naphtha and diesel, also strongly impact the financial results. Changes of 25% in each product value would impact ROI by two to four percentage points.

Table ES-4 Range of Values Used in the Sensitivity Analysis

Model Inputs	Base	(+25%) High Range	(-25%) Low Range
Delivered Coal Price (\$/ton)	36.63	46	27
Electric Tariff (\$/MWh)	52	65	39
Naphtha (\$/gallon)	1.50	1.88	1.13
Diesel (\$/gallon)	1.96	2.45	1.47
Sulfur (\$/ton)	10	12.5	7.5
EPC Cost (\$MM)	2807	3509	2105
O&M Cost (\$MM)	213.6	267.0	160.2
Loan Interest Rate (%)	8	10	6
Availability (%)	85	106	64
Project Life (Yrs)	30	38	23
Debt Financing (%)	55	69	41
Tax Rate (%)	40	50	30

Figure ES-2 Relative Sensitivities of Major Plant Inputs, ±25%

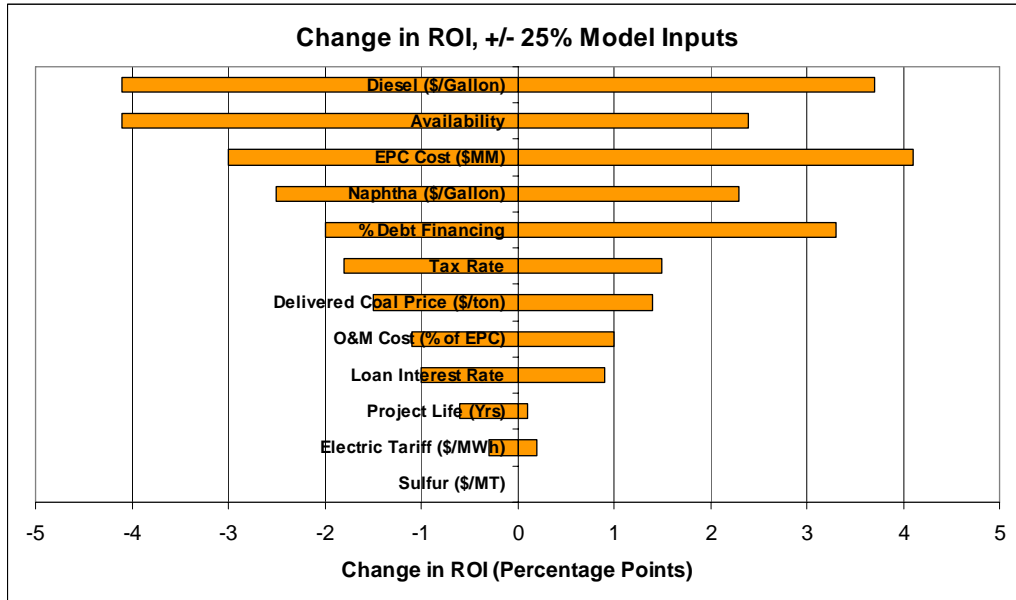
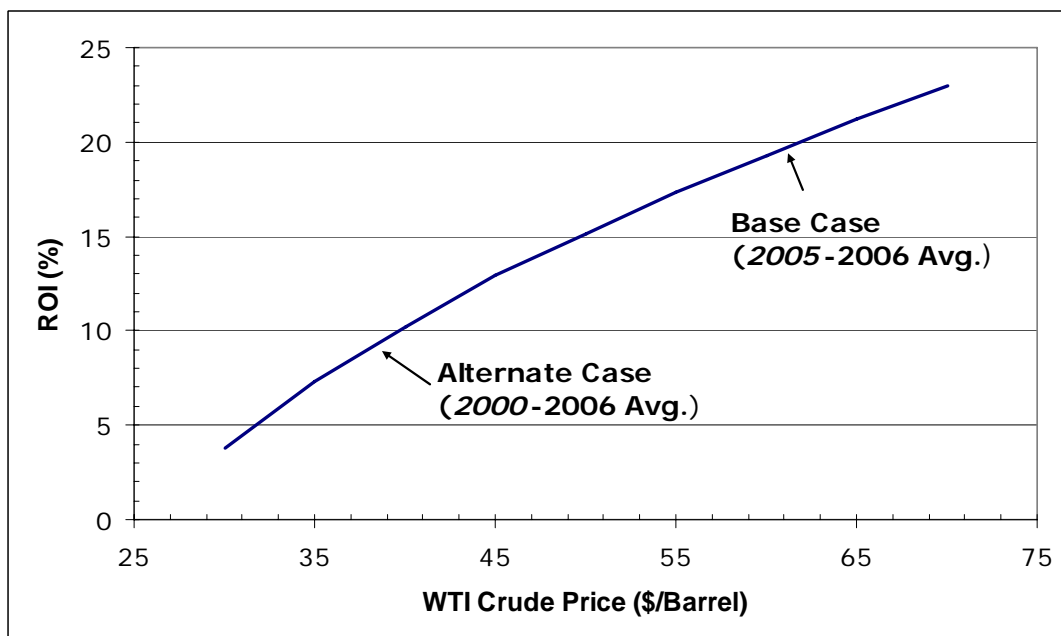

Figure ES-3 illustrates the impact of crude oil prices on plant ROI. ROIs in excess of 10% are possible at crude oil prices greater than \$37/bbl; if project developers feel that the price of crude will remain above this level for the life of the project, naphtha and diesel produced from coal would be competitive with similar streams from crude oil. For comparison purposes, two crude oil reference price scenarios were considered: a base case tied to average crude prices of \$61/bbl in 2005-2006, and an alternate case tied to an average \$38/bbl price in 2000-2006. A change of this magnitude in the value of crude oil could potentially change the decision of whether or not a plant is built.

Figure ES-3 Impact of Petroleum Prices on Plant ROI



Various policy initiatives at the state and federal level could support development of commercial-scale CTL plants. The financial analysis considered three policy initiatives, each evaluated independently: (1) a 50 cent/gallon subsidy on F-T liquids, (2) federal loan guarantees changing the debt/equity ratio and the cost of capital, and (3) a \$130MM investment tax credit. Table ES-5 presents the results of the analysis, showing the ROI and NPV (net present value) for each alternative at a 12% discount rate.

Table ES-5 Financial Impact of Policy Initiatives

	ROI	NPV at 12%, \$MM
Base Case	19.8	1,543
F-T Subsidies	28.7	3,386
Loan Guarantees	31.1	2,067
Investment Tax Credit	20.4	1,625

The use of loan guarantees has the largest impact on overall plant economics, increasing the ROI from 19.8% to 31.1%. It is the change in the debt-to-equity ratio, and not the change in the loan interest rate, that is responsible for the majority of the benefit. For projects with strongly positive cash flows throughout the life of the project, reducing the up-front capital required by increasing the amount of debt will have a greater impact on ROI than reducing the interest payments. This also reduces the risk to equity investors by limiting their financial exposure.

Subsidies on the value of FT products also have a very positive impact on the financial returns. This scenario has a higher equity investment relative to the loan guarantees case, raising the equity investor NPV substantially. Because CTL plants are sensitive to the value of the F-T liquid products, policies that reduce the price volatility risk would be of particular interest to project developers. Implementing price subsidies that vary with the price of crude oil would help to reduce the potential burden on the U.S. Treasury. This analysis assumes that once excise tax credits are paid, any remaining credits could be used against income tax.

Relative to the other two policies considered, the investment tax credit is of lesser assistance to a project developer. Providing a tax credit capped at \$130 million in a project with a total investment of more than \$4 billion has a small net impact. One positive of the tax credit, however, is that it can be claimed by the developer in the first year of plant operation.

CONCLUSIONS

The following conclusions should be viewed in the context that this study is a feasibility analysis. Further detailed examination is required to verify the accuracy of these conclusions.

- The conceptual design evaluated is technically feasible using equipment that has been demonstrated at commercial scale, although no commercial CTL plants are currently operating in the U.S.
- The conceptual design uses high sulfur bituminous coal to produce distillate and naphtha liquid pools via indirect coal liquefaction (F-T process). With the addition of additives, the distillate can be converted to a saleable diesel fuel. The naphtha liquids can be shipped to a refinery for upgrading into gasoline or directly marketed as a chemical feedstock.
- This plant produces 22,173 bbls/day of liquid naphtha that is shipped to a refinery for further upgrading to commercial grade products or for use as a chemical feedstock. The plant also produces 27,819 bbls/day of diesel product. The total coal input requirements are 24,533 tons/day of Illinois #6 coal. All production figures are calculated at 100% of design capacity.
- The plant produces a net power output of 124 MWe which can be exported to the grid. Total sulfur production is 612 tons per day and total carbon dioxide capture is 32,481 tons per day.
- The total plant cost is \$3.65 billion. Total capital costs including working capital; start up costs, and owners costs are \$4.07 billion. Adding allowances for financing costs results in a total project cost of \$4.53 billion.
- Commercial-scale CTL plants using Midwestern bituminous coal represent promising economic opportunities. Based on the specific plant configuration evaluated, the financial analysis projects a nearly 20% return on investment, a net present value of more than \$1.5 billion, and a payback period of 5 years.
- Plant capacity factor and EPC costs have a strong impact on the financial analysis but even with major changes to these inputs, positive financial returns are still possible. For example, a capacity factor reduction of 25% would lower ROI from 20% to 15%, and a 25% increase in EPC would reduce the ROI to 17%.
- Project viability depends heavily on crude oil price scenarios. The base case, tied to a crude oil price of \$61/bbl, provides a 19.8% ROI. At crude oil prices greater than \$37/bbl, the project would achieve ROIs greater than 10%, and a 15% ROI can be achieved at crude oil prices greater than \$47/bbl.
- Policy actions impact expected ROIs. Federal loan guarantees have the largest ROI impact, increasing the ROI by more than 11 percentage points from the base case. F-T subsidies provide a 9 percentage point increase in ROI.

CONTRIBUTIONS AND ACKNOWLEDGEMENTS

This work was funded by the U.S. Department of Energy's National Energy Technology Laboratory (U.S. DOE-NETL). The NETL sponsor for this project was Daniel Cicero, Technology Manager for Hydrogen and SynGas in the office of Coal and Power R&D. Michael Reed of the Office of Systems Analysis and Planning (OSAP) was the NETL Technical Monitor for this work. John Wimer, the Systems Team Leader for OSAP, worked closely with Michael. This NETL management team provided guidance and technical oversight for this study. The authors would like to acknowledge the significant role played by U.S. DOE/NETL in providing the programmatic guidance and review of this report.

TECHNICAL CONTRIBUTORS

Daniel Cicero	Technology Manager, SCC, NETL
Michael Reed	Project Technical Monitor, OSAP, NETL
John Wimer	Systems Team Leader, OSAP, NETL
Larry Van Bibber	Subtask Manager, RDS/SAIC
John Haslbeck	Design Leader, RDS/Parsons
Sheldon Kramer	F-T Plant Analysis RDS/Nexant
Erik Shuster	F-T Plant Analysis RDS/SAIC
Howard McIlvried	F-T Plant Consultant RDS/SAIC
Scott Olson	Financial Analysis Leader RDS/Nexant
Mike Rutkowski	Design and Costing RDS/Parsons
William McMahon	Cost Engineer, RDS/Econ Opportunities, Inc.
John Marano	F-T Plant Consultant

TABLE OF CONTENTS

BACKGROUND	1
EXECUTIVE SUMMARY	2
OVERVIEW	2
PLANT DESIGN	2
FINANCIAL ANALYSIS	4
CONCLUSIONS	8
CONTRIBUTIONS AND ACKNOWLEDGEMENTS	10
TECHNICAL CONTRIBUTORS	10
TABLE OF CONTENTS	11
LIST OF FIGURES	12
ACRONYMS AND ABBREVIATION	13
1. INTRODUCTION.....	17
2. PLANT DESIGN BASIS	18
2.1 SITE DESCRIPTION	18
2.2 DESIGN FUEL CHARACTERISTICS	19
2.2 ENVIRONMENTAL REQUIREMENTS	19
2.2.1 <i>Carbon Dioxide</i>	21
2.2.2 <i>Mercury</i>	21
2.2.3 <i>Raw Water Usage</i>	21
2.3 BALANCE OF PLANT	22
3. PLANT ANALYSIS.....	24
3.1 ASSUMPTIONS FOR ANALYSIS	24
3.2 ANALYSIS OF PLANT CONCEPT	24
3.2.1 <i>Process Description with Block/Process Diagrams</i>	25
3.2.2 <i>Heat and Mass Balances</i>	27
3.2.3 <i>Performance Summary</i>	31
3.2.4 <i>F-T Output Summary</i>	32
4. PLANT DESIGN.....	33
4.1 COMMERCIAL SCALE COAL-TO-LIQUIDS FACILITY	33
4.1.1 <i>Description</i>	33
4.1.2 <i>Major Equipment List</i>	42
4.1.3 <i>Capital Costs</i>	42
4.1.4 <i>Operating and Maintenance Costs</i>	43
5. FINANCIAL ANALYSIS.....	46
6. CONCLUSIONS	59
6.1 RECOMMENDATIONS FOR FURTHER STUDY	59
APPENDIX A DETAILED EQUIPMENT LISTS	62
APPENDIX B FINANCIAL MODEL ENTRIES	72

LIST OF FIGURES

Figure ES-1 F-T Block Flow Diagram and Performance Characteristics	4
Figure ES-2 Relative Sensitivities of Major Plant Inputs, $\pm 25\%$	7
Figure ES-3 Impact of Petroleum Prices on Plant ROI	7
Figure 3-1 Process Block Flow Diagram.....	27
Figure 4-1 Cluster Plant Process Diagram.....	35
Figure 5-1 Key Plant Inputs/Outputs, Nominal 50,000 BBL/Day Illinois F-T Liquids Plant	46
Figure 5-2 Relative Sensitivities of Major Plant Inputs, $\pm 25\%$	52
Figure 5-3 PADD 2 Petroleum Product Values.....	53
Figure 5-4 Impact of Petroleum Prices on Plant ROI.....	54
Figure 5-5 Effect of Availability on Project ROI	55

LIST OF TABLES

Table ES-1 Plant Performance Summary	4
Table ES-2 Total Plant Costs (\$millions).....	5
Table ES-3 Financial Analysis Results.....	5
Table ES-4 Range of Values Used in the Sensitivity Analysis	6
Table ES-5 Financial Impact of Policy Initiatives.....	8
Table 2-1 Generic Site Ambient Conditions.....	18
Table 2-2 Generic Site Characteristics	18
Table 2-3 Illinois No. 6 Design Coal	19
Table 2-4 BACT Guidelines	20
Table 2-5 Standards of Performance for Electric Utility Steam Generating Units.....	20
Table 2-6 Process and Cooling Water Properties	23
Table 3-1 Process Stream Compositions, Temperatures, Pressures, and Flows.....	28
Table 3-2 Plant Performance Summary	31
Table 3-3 Naphtha Components	32
Table 3-4 Diesel Components.....	32
Table 4-1 Concept 1 - Total Plant Cost Summary	44
Table 4-2 Concept 1 - Operating and Maintenance Expenses.....	45
Table 5-1 Financial Model Results	49
Table 5-2 Total Plant Costs.....	50
Table 5-3 Range of Values Used in the Sensitivity Analysis	51
Table 5-4 Financial Impacts on Evaluated Policies.....	57

ACRONYMS AND ABBREVIATION

A/E	Architect/engineer
acfm	Actual cubic feet per minute
AACE	Association for the Advancement of Cost Engineering
AFBC	Atmospheric fluidized-bed combustors
AFDC	Allowance for funds used during construction
AGR	Acid gas removal
ANSI	American National Standards Institute
ASME	American Society of Mechanical Engineers
ASU	Air separation unit
ATS	Advanced turbine system
BACT	Best available control technology
Bbl/day	barrels per day
Btu	British thermal unit
CAAA	Clean Air Act Amendments of 1990
CCT	Clean coal technology
CDR	Carbon Dioxide Recovery
cfm	Cubic feet per minute
CFR	Code of Federal Regulations
CGE	Cold gas efficiency
CHAT	Cascaded humidified advanced turbine
CF	Capacity factor
CO ₂	Carbon dioxide
COE	Cost of electricity
COS	Carbonyl sulfide
COE	Cost of electricity
CPFBC	Circulating pressurized fluidized-bed combustors
CRT	Cathode ray tube
CS	Carbon steel
CT	Combustion turbine
CTL	Coal-to-liquids
CWT	Cold water temperature
dB	Decibel
DCS	Distributed control system
DLN	Dry low NO _x
DOE	Department of Energy
E-Gas [™]	Global Energy (now ConocoPhillips) gasifier technology

EPA	Environmental Protection Agency
EPRI	Electric Power Research Institute
ESP	Electrostatic precipitator
ETA	Effective thermal efficiency
FBHE	Fluidized-bed heat exchanger
FD	Forced draft
FERC	Federal Energy Regulatory Commission
FGD	Flue gas desulfurization
FOAK	First of a kind
FRP	Fiberglass-reinforced plastic
F-T	Fischer-Tropsch
gpm	Gallons per minute
GJ	Gigajoule
GT	Gas turbine
h, hr	Hour
H ₂	Hydrogen
H ₂ SO ₄	Sulfuric acid
HAP	Hazardous air pollutant
HCl	Hydrochloric acid
HDPE	High density polyethylene
HHV	Higher heating value
hp	Horsepower
HP	High pressure
HRSG	Heat recovery steam generator
HVAC	Heating, ventilating, and air conditioning
HWT	Hot water temperature
Hz	Hertz
in. H ₂ O	Inches water
in. Hga	Inches mercury (absolute pressure)
in. W.C.	Inches water column
ID	Induced draft
IEEE	Institute of Electrical and Electronics Engineers
IGCC	Integrated gasification combined cycle
IOU	Investor-owned utility
IP	Intermediate pressure
IPP	Independent power producer
IRP	Integrated resource planning
ISO	International Standards Organization

ITM	Ion transfer membrane
kPa	Kilopascal absolute
kV	Kilovolt
kW	Kilowatt
kWe	Kilowatts electric
kWh	Kilowatt-hour
kWt	Kilowatts thermal
LAER	Lowest achievable emission rate
lb	Pound
LCOE	Levelized cost of electricity
LASH	Limestone ash
LEBS	Low emissions boiler systems
LHV	Lower heating value
LP	Low pressure
MC	Mitigation cost
MAF	Moisture and Ash Free
MCR	Maximum coal burning rate
MDEA	Methyldiethanolamine
MEA	Monoethanolamine
MHz	Megahertz
MMBtu	Million British thermal units (also shown as 10^6 Btu)
MMBtuh	Million British thermal units (also shown as 10^6 Btu) per hour
MPa	Megapascals absolute
MWe	Megawatts electric
MWh	Megawatts-hour
MWt	Megawatts thermal
NETL	National Energy Technology Laboratory
N/A	Not applicable
NAAQS	National Ambient Air Quality Standards
NGCC	Natural gas combined cycle
NM ³	Normal Cubic meter
NO _x	Oxides of nitrogen
NSPS	New Source Performance Standards
O&M	Operations and maintenance
OD	Outside diameter
OP/VWO	Over pressure/valve wide open
OTR	Ozone transport region
PA	Primary air

PC	Pulverized coal
pph	Pounds per hour
ppmvd	Parts per million volume, dry
PSA	Pressure Swing Adsorption
psia	Pounds per square inch absolute
psid	Pounds per square inch differential
psig	Pounds per square inch gage
QF	Qualifying facility
RDS	Research Development Solutions, LLC
RPD	Restricted pipe discharge
rpm	Revolutions per minute
SC	Supercritical
SCFD	Standard cubic feet per day
scfm	Standard cubic feet per minute
scmh	Standard cubic meter per hour
SCOT	Shell Claus Off-gas Treating
SCR	Selective catalytic reduction
SIP	State implementation plan
SNCR	Selective non-catalytic reduction
SO ₂	Sulfur dioxide
SOFC	Solid oxide fuel cell
SS	Stainless steel
TAG	Technical Assessment Guide
ST	Steam turbine
TCR	Total capital requirement
TGTU	Tail gas treating unit
TPC	Total plant capital (cost)
THGD	Transport hot gas desulfurizer
TPC	Total plant cost
tpd	Tons per day
tph	Tons per hour
TPI	Total plant investment
V-L	Vapor Liquid portion of stream (excluding solids)
WB	Wet bulb
wt%	Weight percent

1. INTRODUCTION

The rise in petroleum and natural gas prices over the last few years, coupled with increasing U.S. dependence on foreign suppliers of liquid fuels, has sparked strong national interest in alternative sources of energy. Various supply-side and demand-side options have been proposed to reduce oil imports and apply downward pressure on prices, including higher vehicle fuel efficiency, the use of renewable fuels such as ethanol, and greater access to domestic fuel resources offshore and on Federal lands.

The production of liquid fuels from coal – America’s most abundant fuel resource – provides another option. Liquefaction technologies that can produce liquid fuels from coal have existed for more than 80 years. The most widely used coal liquefaction technology employs an indirect process in which the coal is gasified into a synthesis gas that is then converted into liquid fuels using the Fischer-Tropsch (F-T) process. Commercial coal-to-liquid (CTL) plants are in operation in South Africa, the largest of which produces 124,000 barrels per day (bbl/day) of light olefins and gasoline from coal. Commercial CTL plants have not been built in the United States, primarily because the price of coal-derived liquid fuels has been unable to compete with the price of fuels derived from crude oil.

In light of recent high prices for crude oil, commercial-scale CTL plants are attracting renewed attention. This report summarizes the results of a technical and economic assessment of a 50,000 barrel/day (bbl/day) CTL plant at a generic site in the Illinois coal basin.

The conceptual plant design features the ConocoPhillips E-Gas gasification technology and an F-T reactor system using an iron-based catalyst. The design includes a cluster of four gasification plants, each containing two gasifier trains for a total of eight gasifier trains. The F-T plant contains reactors, hydrotreating units and hydrocracking units capable of producing 27,819 bbl/day of commercial-grade diesel liquid and 22,173 bbl/day of naphtha liquids, which could be shipped to a refinery for further upgrading into commercial-grade end products or for use as a chemical feedstock. The CTL plant also generates electric power, mostly for internal use with excess exported to the grid. The plant design includes equipment to capture and compress carbon dioxide to 2200 psia for injection into a pipeline. Subsequent carbon dioxide use and/or sequestration are not considered in this design.

This report details the technical and economic assessment of the CTL plant, and includes conceptual design assumptions, equipment descriptions and lists, process flow diagrams, heat and material balances, and energy and performance summaries. Also included are estimates of capital, operating and maintenance costs, and a financial analysis of the commercial viability of the concepts under various sets of economic assumptions.

2. PLANT DESIGN BASIS

2.1 Site Description

The characteristics of a generic plant site in the Illinois coal basin are presented in Table 2-1 and Table 2-2.

Table 2-1 Generic Site Ambient Conditions

Elevation, ft	0
Barometric Pressure, psia	14.696
Design Ambient Temperature, Dry Bulb, °F	59
Design Ambient Temperature, Wet Bulb, °F	51.5
Design Ambient Relative Humidity, %	60

Table 2-2 Generic Site Characteristics

Location	Illinois coal basin
Topography	Level
Size, acres	300
Transportation	Road, Rail, Barge, Pipeline
Ash/Slag Disposal	Off Site
Water	River
CO ₂ Storage	Not considered

The following design parameters are considered site-specific, and are not quantified in this study. Allowances for normal conditions and construction requirements, however, are included in the cost estimates.

- Flood plain considerations
- Existing soil/site conditions
- Water discharges and reuse
- Rainfall/snowfall criteria
- Seismic design
- Fire protection
- Local code height requirements
- Noise regulations – Impact on site and surrounding area

2.2 Design Fuel Characteristics

The design coal for this study is Illinois No. 6 coal. The coal characteristics are presented in Table 2-3.

Table 2-3 Illinois No. 6 Design Coal

Rank	High Volatile Bituminous	
Seam	Illinois #6 (Herrin)	
Source	Old Ben mine	
Proximate Analysis (weight %) [Note A]		
	As Rec'd	Dry
Moisture	11.12	0.00
Ash	9.70	10.91
Volatile Matter	34.99	39.37
Fixed Carbon	44.19	49.72
HHV, Btu/lb	11,666	13,126
Ultimate Analysis (weight %)		
	As Rec'd	Dry
Carbon	63.75	71.72
Moisture	11.12	0.00
Hydrogen	4.50	5.06
Nitrogen	1.25	1.41
Chlorine	0.29	0.33
Sulfur	2.51	2.82
Ash	9.70	10.91
Oxygen [Note B]	6.88	7.75
Total	100.00	100.00

Notes: A. The above proximate analysis assumes that sulfur is volatile matter

B. By difference

2.2 Environmental Requirements

The environmental control equipment used in the conceptual design conforms to Best Available Control Technology (BACT) guidelines. Specific emission limits and the corresponding environmental control equipment are summarized in Table 2-4.

Table 2-4 BACT Guidelines

Pollutant	Gasification Technologies	
	Control Technology	Limit
Sulfur	Selexol/Econamine Plus/Sulfinol-M + Claus Plant	99+% or ≤ 0.050 lb/10 ⁶ Btu
NO_x	Low-NO _x Burners and N ₂ Dilution	15 ppmvd (@ 15% O ₂)
PM	Cyclone/Barrier Filter/Wet Scrubber/AGR Absorber	0.006 lb/10 ⁶ Btu
Hg	Activated Carbon Bed	95% removal

The current regulations governing new, reconstructed, or modified fossil-fuel fired power plants are the New Source Performance Standards (NSPS) published in February 2006 and shown in Table 2-5. These NSPS standards supersede the previous NSPS standards established in 1978. The new standards apply to units with the capacity to generate greater than 73 MW of power by burning fossil fuels, as well as cogeneration units that sell more than 25 MW of power and more than one-third of their potential output capacity to any utility power distribution system. The rule also applies to combined-cycle plants, IGCC plants, and combined heat and power combustion turbines that burn 75 percent or more synthetic-coal gas.

Table 2-5 Standards of Performance for Electric Utility Steam Generating Units Built, Reconstructed, or Modified After February 28, 2005

	New Units		Reconstructed Units		Modified Units	
	Emission Limit	% Reduction	Emission Limit (lb/10 ⁶ Btu)	% Reduction	Emission Limit (lb/10 ⁶ Btu)	% Reduction
PM	0.015 lb/10 ⁶ Btu	99.9	0.015	99.9	0.015	99.8
SO₂	1.4 lb/MWh	95	0.15	95	0.15	90
NO_x	1.0 lb/MWh	N/A	0.11	N/A	0.15	N/A

There are currently no BACT guidelines or NSPS regulations that apply specifically to coal-to-liquid plants. Guidelines and regulations applicable to new IGCC plants were used in this study. The BACT technologies assumed for this study meet the emission requirements of the 2006 NSPS; however, some state and local requirements could supersede NSPS and impose even more stringent requirements.

2.2.1 Carbon Dioxide

The plant design includes equipment to capture and compress carbon dioxide to 2200 psia for injection into a pipeline. The design does not include systems for subsequent carbon dioxide use/sequestration.

2.2.2 Mercury

The plant design assumes mercury capture of 95% via activated carbon, based on data from the Eastman Chemical Company's gasification facility in Kingsport, Tennessee. EPA has determined that some mercury is captured in systems conventionally used to capture PM, sulfur, and nitrogen oxides. Oxidized mercury is captured in fabric filters and electrostatic precipitators, wet and dry flue gas desulfurization (FGD) systems, and selective catalytic reduction and selective non-catalytic reduction (SCR/SNCR) systems. The co-benefit of mercury capture in these systems is particularly high for bituminous coals (such as the Illinois #6 coal used in this study), ranging from 84 to 98%. The analysis estimates co-benefit mercury capture in the F-T plant and factors the result into the design of the activated carbon mercury control system.

2.2.3 Raw Water Usage

Raw water makeup is provided by the local river. The plant is equipped with an evaporative cooling tower, and all process blowdown streams are treated and recycled to the cooling tower.

2.3 Balance of Plant

Assumed balance-of-plant requirements are as follows:

Cooling system	Recirculating, evaporative cooling tower or hybrid air/water cooling tower.
<u>Fuel and Other Storage</u>	
Coal	30 days
Slag	30 days
Sulfur	30 days
<u>Plant Distribution Voltage</u>	
Motors below 1 hp	110/220 volt
Motors 250 hp and below	480 volt
Motors above 250 hp	4,160 volt
Motors above 5,000 hp	13,800 volt
Steam and gas turbine generators	24,000 volt
Grid interconnection voltage	345 kV
<u>Water and Waste Water</u>	
Makeup water	Process water is available from the river or from existing or new wells at a flow rate of 1,500 gpm.
Feedwater	Treatment of the water supply is included and will produce boiler feed quality water for the IGCC plant.
Process wastewater	Water associated with gasification activity and storm water that contacts equipment surfaces will be collected and treated for discharge through a permitted discharge facility.
Sanitary waste disposal	Design will include a packaged domestic sewage treatment plant with effluent discharged to the industrial wastewater treatment system. Sludge will be hauled off site.
Water discharge	Most of the wastewater will be recycled for plant needs. Blowdown will be treated for chloride and metals, and discharged.
Solid waste	<p>Gasifier slag is assumed to be a solid waste that is classified as non-hazardous.</p> <p>An offsite waste disposal site is assumed to have the capacity to accept waste generated throughout the life of the facility.</p> <p>Solid waste sent to disposal is at an assumed nominal fee per ton, even if the waste is hauled back to the mine.</p> <p>Solid waste that can be recycled or reused is assumed to have a zero cost</p>

Process water and cooling water come from two different treatment facilities. Their composition and physical properties are shown in Table 2-6.

Table 2-6 Process and Cooling Water Properties

Property	Process Water	Cooling Water
Total Dissolved Solids (TDS)	200 μ S/cm	1250 μ S/cm
Total Suspended Solids (TSS)	Not Available	Not Available
Hardness	100 mg/l as CaCO ₃	75 mg/l as CaCO ₃
Alkalinity	100 ppm	350 ppm
Sulfate	4 ppm	50 ppm
Chloride	10 ppm	200 ppm
Silica	30 mg/l	30 mg/l
Aluminum	Not Available	Not Available
Iron	0.25 mg/l	0.25 mg/l
Calcium	70 mg/l	25 mg/l
Magnesium	25 mg/l	45 mg/l
Phosphate	0.4 mg/l	6.0 mg/l (ortho)
Ammonia	<1 mg/l	19 mg/l
Chlorine	<0.1 mg/l	<0.1 mg/l
pH	8.0	8.0

3. PLANT ANALYSIS

3.1 Assumptions for Analysis

The conceptual design is based on a generic location in Illinois, using Illinois No. 6 as the design coal.

The design and operation of the gasifier system is based on a model developed using public domain information. The gasification system consists of a multi-train ConocoPhillips (E-Gas™) slurry feed gasifier configuration with three 6FA-class combustion turbines. The turbines were selected for operating flexibility. Three turbines, each having one-third of the design capacity, provide operating flexibility when upstream portions of the plant are not operating. A 2-stage Selexol acid gas removal system is used to remove both sulfur components and carbon dioxide. A Claus sulfur recovery system is used for sulfur recovery. The design and operation of the slurry-bed, iron-based catalyst F-T reactor system is also based on a model developed from public information. The F-T model used was originally developed by Bechtel/Amoco in 1993.¹

The plant captures carbon dioxide, dries it, and compresses it to 2200 psia. The plant configuration does not include sequestration, but does include all pollution control technologies needed to meet existing Federal regulations.

3.2 Analysis of Plant Concept

The plant configuration consists of a coal-to-liquids (CTL) facility fed with syngas from four dual train gasification systems for full-load operation.

The following parameters and assumptions are the basis for the study:

- The CTL plant will be self-sufficient in terms of electric power requirements; however, extra power may be exported to the grid.
- The F-T system utilizes recycle and other reasonable unit operations to maximize liquid fuels production.
- The F-T system includes sufficient upgrading capabilities to produce commercial-grade diesel fuel and to produce other liquid products or chemical feedstocks that can be shipped to a conventional oil refinery or chemical plant. Commercial-grade diesel fuel is a product that can be shipped to a distributor, treated with additives and sold to an end-use customer.

¹ Baseline Design/Economics for Advanced Fischer-Tropsch Technology, DOE Contract No. DE-AC22-91PC90027, Topical Report Volume 1, Process Design – Illinois No. 6 Coal Case with Conventional Refining, October, 1994.

- The nominal size of the plant is assumed to be the production of 50,000 bbl/day of F-T liquids.
- The plant will be located in the Illinois coal basin.
- The necessary electric equipment to connect the power production to the utility grid will be included in the design and cost estimation portion of this study.
- The site is assumed to have appropriate access to rail transportation for delivery of coal. All local coal handling facilities will be included in the design and cost estimation portion of this study.
- The plant will include necessary hydrocracking processing equipment to convert the wax F-T product into a product capable of being pumped to the refinery.
- The plant will have access to necessary pipeline facilities to transfer the hydrocracked blend product to a US refinery. These facilities and costs are not part of the scope of the system.
- ConocoPhillips (E-Gas) gasification with appropriate environmental control systems necessary to meet applicable air quality regulations will be employed.
- Electricity production is kept at a low level but enough to keep the plant self-sustaining.
- The F-T reactor section will use a high alpha iron (Fe) based catalyst system. The reactor design will incorporate the latest knowledge of slurry based reactor systems.
- The plant will employ carbon capture technology and include compression of the captured CO₂ to pipeline pressure (2200 psia)

3.2.1 Process Description with Block/Process Diagrams

The block flow diagram is shown in Figure 3-1. The objective of the process design is to maximize liquids production by recycling the unconverted F-T reactor off-gases after CO₂ removal.

The dedicated gasifier trains are fueled with Illinois No. 6 coal. The coal is pulverized and mixed with water to make a slurry. The ConocoPhillips (E-Gas) coal gasification technology features a two-stage oxygen-blown, entrained flow, refractory-lined gasifier with continuous slag removal. The coal slurry reacts with oxygen in the gasifier at about 1,900°F. A dedicated air separation unit supplies 95% purity oxygen to the gasifiers. Syngas leaving the gasifier is cooled in a fire tube syngas cooler, producing high-pressure steam. The raw syngas is quenched and further cooled in a water scrubber to remove particulates and trace components.

The syngas stream is reheated and passed through a COS hydrolysis reactor in which the COS and HCN are hydrolyzed to H₂S, followed by additional cooling, where water and nearly all of the ammonia are removed.

The syngas then passes through a mercury removal system, based on technology used at Eastman Chemical Company's gasification facility in Kingsport, Tennessee. Beds of sulfur-impregnated activated carbon provide a 20-second superficial gas residence time to achieve greater than 95% mercury removal. Other volatile heavy metals such as arsenic are also removed.

H₂S is preferentially removed from the cool, particulate-free gas stream by a Selexol process, producing a concentrated CO₂ product stream. The stripped H₂S stream goes to a Claus plant to produce elemental sulfur. CO₂ is removed from the syngas in the second stage of the Selexol absorber. The stripped CO₂ is dehydrated and compressed to 2,200 psia.

Clean syngas leaving the Selexol unit contains less than 1 ppm total sulfur. The sulfur level is further reduced to less than 1 ppb using a zinc oxide sulfur polishing bed. This sweet syngas represents the feed for the F-T process, which produces an essentially sulfur-free diesel fuel.

Clean syngas from the gasification area is sent to the F-T slurry reactors to produce the hydrocarbon products. Because syngas conversion per pass is less than 100%, unconverted syngas is recycled to maximize liquid production. Cooling tubes are located within the reactor to produce steam that is ultimately used to generate auxiliary power. Two reactor effluent streams are produced. The liquid reactor effluent stream is cooled and then flashed. The liquid is sent to the distillation column.

The overhead vapor stream from the F-T reactors is cooled. The aqueous phase and condensed hydrocarbon liquids are separated. The liquid hydrocarbons are further cooled and sent to the hydrocarbon recovery section. The vapor stream goes to the carbon dioxide removal unit. CO₂ is removed with an amine process to be dehydrated and compressed to 2200 psia. The CO₂ lean vapor is then compressed, dehydrated, and sent to the hydrocarbon recovery plant. The hydrogen recovery plant produces high-purity hydrogen for the product upgrading units. Hydrogen is removed by a pressure swing absorption unit. The vapor then goes to an autothermal reformer, where it is mixed with steam and oxygen to minimize the buildup of light ends in the recycle loop by converting them to syngas.

In the distillation column, the F-T liquid product is separated into light components, naphtha, distillate, and wax fractions for further processing. All the light-end components (C₄s and lighter) from the F-T process provide fuel gas to the combustion turbine, although the butanes and propane (LPG) could be recovered and sold if a market for these materials were available. The naphtha fraction is catalytically hydrotreated to produce a stable naphtha, the distillate fraction is catalytically hydrotreated to produce diesel, and the wax fraction is catalytically hydrocracked to produce diesel and naphtha cuts.

The F-T process converts the clean syngas to 49,992 barrels per day of total liquids, 22,173 barrels per day of naphtha and 27,819 barrels per day of distillate. The distillate

is blended with the required additives to produce a saleable grade diesel fuel. The liquids are shipped off-site either by rail or barge.

The off-gas from the F-T process is compressed and used as fuel for the three GE 6FA gas turbines that produce a total of 251 MWe. A duct burner is placed after the gas turbines to consume any fuel gas not combusted in the gas turbine. Hot flue gas from the gas turbine passes through a HRSG in which superheated high-pressure steam is produced. The resulting steam is combined with that produced by cooling the syngas from the gasification train and with that generated by recovering heat from the F-T reactors and expanded in a multi-stage steam turbine to produce 401 MWe.

The net plant export power, after plant auxiliary power requirements are deducted, is nominally 124 MWe.

Figure 3-1 Process Block Flow Diagram
ConocoPhillips (E-Gas) Gasifier-Based F-T Liquid Production Plant

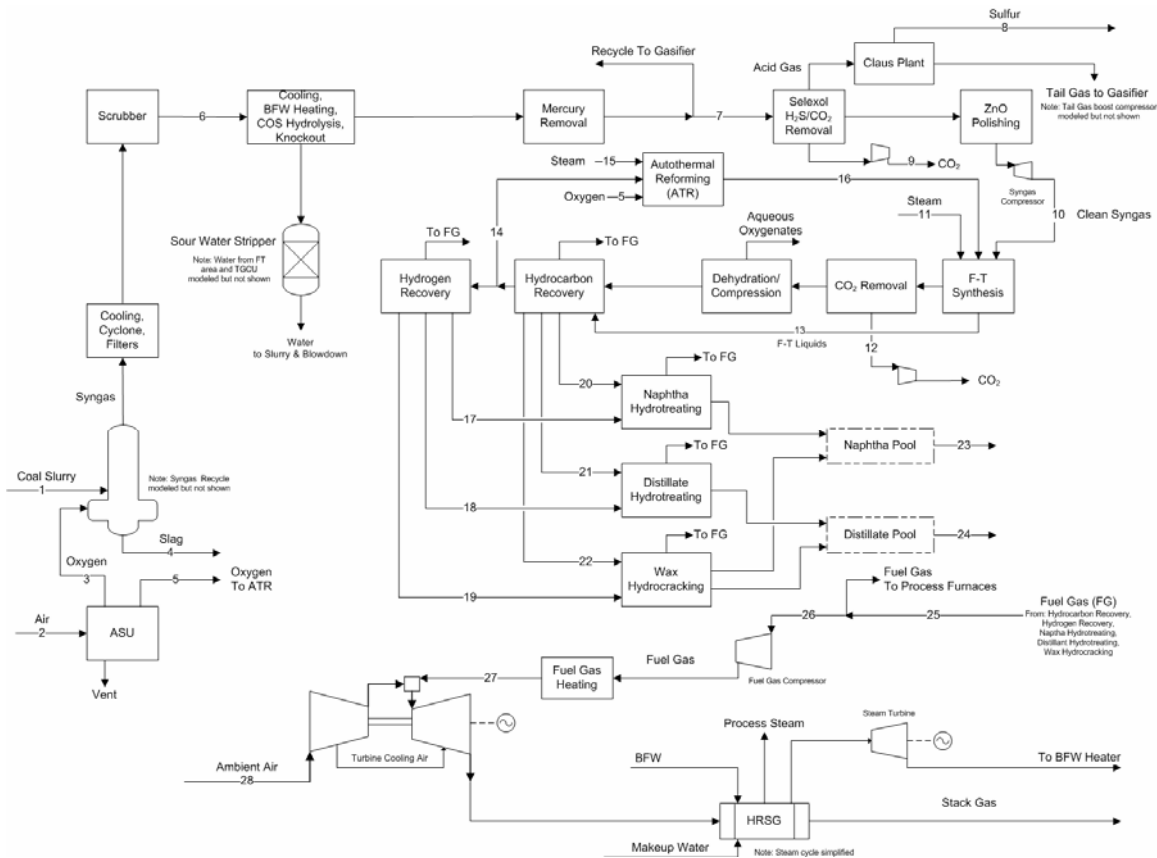

3.2.2 Heat and Mass Balances

Table 3-1 shows the temperature, pressure and flow of the process streams in the gasification and F-T areas at the design feed rate, including stream compositions and state points.

Table 3-1 Process Stream Compositions, Temperatures, Pressures, and Flows

	1A	2	3	4	5	6	7	8	9	10
	Slurry	Air	Oxygen	Slag	Oxygen	Syngas	Syngas	Sulfur	CO2	Syngas
V-L Mole Fraction										
Ar	0	0.0094	0.0360	0	0.0322	0.0100	0.0114	0	0	0.0136
CH4	0	0	0	0	0	0.0279	0.0317	0	0	0.0380
CO	0	0	0	0	0	0.4040	0.4585	0	0	0.5495
CO2	0	0.0003	0	0	0	0.1387	0.1580	0	1.0	0.0073
COS	0	0	0	0	0	0.0005	0	0	0	0.0000
H2	0	0	0	0	0	0.2773	0.3147	0	0	0.3771
H2O	1.0	0.0104	0	0	0	0.1193	0.0027	0	0	0.0001
H2S	0	0	0	0	0	0.0080	0.0096	0	0	0
N2	0	0.7722	0.0140	0	0.0178	0.0120	0.0136	0	0	0.0144
NH3	0	0	0	0	0	0.0023	0	0	0	0
O2	0	0.2077	0.95	0	0.950	0	0	0	0	0
SO2	0	0	0	0	0	0	0	0	0	0
Total	1.0	1.0	1.0	0.0	1.0	1.0	1.0	0.0	1.0	1.0
V-L Flowrate (lbmol/hr)	51,959	245,503	52,644	0	998	236,754	166,902	0	25,049	139,250
V-L Flowrate (lb/hr)	936,062	7,083,820	1,696,660	0	32,129	5,126,559	3,696,216	0	1,102,390	2,510,720
Solids Flowrate (lb/hr)	1,817,063	0	0	205,858	0	0	0	51,021	0	0
Temperature (°F)	60	59	305	1,850	305	285	103	344	155	676
Pressure (psia)	500.0	14.4	560.0	500	375.0	434.2	372.8	23.6	2,214.7	360.0
Density (lb/ft ³)	---	0.075	2.199	---	1.471	1.177	1.378	---	30.975	0.533
Molecular Weight	---	28.85	32.23	---	32.18	21.65	22.15	---	44.01	18.03

**Table 3-1 Process Stream Compositions, Temperatures, Pressures, and Flows
(Continued)**

	11	12	13	14	15	16	17	18	19	20
V-L Mole Fraction	Water	CO2	F-T Liquids	Recycle	Steam	Recycle	H2	H2	H2	F-T Liquids
H2	0	0	0.0082	0.48330	0	0.56100	1.0	1.0	1.0	0
N2	0	0	0.0077	0.30834	0	0.20678	0	0	0	0
O2	0	0	0	0	0	0	0	0	0	0
H2S	0	0	0	0	0	0.000000	0	0	0	0
CO	0	0	0.000916	0.03821	0	0.11156	0	0	0	0
CO2	0	1.0	0.038638	0.00251	0	0.01027	0	0	0	0
H2O	1.0	0	0.057086	0	1.0	0.08425	0	0	0	0
NH3	0	0	0.000000	0	0	0	0	0	0	0
COS	0	0	0	0	0	0	0	0	0	0
CH4	0	0	0.005843	0.15540	0	0.02614	0	0	0	0
C2H4	0	0	0.000524	0.00904	0	0	0	0	0	0
C2H6	0	0	0.000151	0.00217	0	0	0	0	0	0
C3H6	0	0	0.000785	0.00086	0	0	0	0	0	0
C3H8	0	0	0.000147	0.00012	0	0	0	0	0	0
IC4H8	0	0	0.000046	0	0	0	0	0	0	0
NC4H8	0	0	0.000890	0.00005	0	0	0	0	0	0
IC4H10	0	0	0.000011	0	0	0	0	0	0	0
NC4H10	0	0	0.000239	0.00001	0	0	0	0	0	0
C5H10	0	0	0.001006	0	0	0	0	0	0	0.0005712
NC5H12	0	0	0.000355	0	0	0	0	0	0	0.0425484
IC5H12	0	0	0.000037	0	0	0	0	0	0	0
C6H12	0	0	0.001365	0	0	0	0	0	0	0.1839083
NC6H14	0	0	0.000440	0	0	0	0	0	0	0.0551711
IC6H14	0	0	0.000044	0	0	0	0	0	0	0.0061312
C7H14	0	0	0.001567	0	0	0	0	0	0	0.1422941
C7H16	0	0	0.000714	0	0	0	0	0	0	0.0609821
C8H16	0	0	0.001877	0	0	0	0	0	0	0.1180687
C8H18	0	0	0.000858	0	0	0	0	0	0	0.0506007
C9H18	0	0	0.002291	0	0	0	0	0	0	0.0979530
C9H20	0	0	0.001037	0	0	0	0	0	0	0.0419797
C10H20	0	0	0.002694	0	0	0	0	0	0	0.0812565
C10H22	0	0	0.001256	0	0	0	0	0	0	0.0348239
C11-C20 Olefins	0	0	0.061435	0	0	0	0	0	0	0
C11-C20 Paraffins	0	0	0.027211	0	0	0	0	0	0	0
C7-300HC	0	0	0	0	0	0	0	0	0	0
3-350HC	0	0	0	0	0	0	0	0	0	0
350-5HC	0	0	0	0	0	0	0	0	0	0
500+HC	0	0	0	0	0	0	0	0	0	0
C7-300HT	0	0	0	0	0	0	0	0	0	0
3-350HT	0	0	0	0	0	0	0	0	0	0
350-5HT	0	0	0	0	0	0	0	0	0	0
500+HT	0	0	0	0	0	0	0	0	0	0
OxVAP	0	0	0.000216	0	0	0	0	0	0	0
OxHC	0	0	0.002503	0	0	0	0	0	0	0.0837110
OxH2O	0	0	0.000793	0	0	0	0	0	0	0
C21 - C29 Paraffin/Olefin Mix	0	0	0.165293	0	0	0	0	0	0	0
C30+Waxes	0	0	0.605880	0	0	0	0	0	0	0
Total	1.0000	1.0000	1.0000	1.0000	1.0000	1.0000	1.0000	1.0000	1.0000	1.0000
V-L Flowrate (lbmol/hr)	4,778	36,455	587	33,251	7,423	49,826	830	410	2,159	1,080
V-L Flowrate (lb/hr)	86,076	1,604,370	313,745	453,857	133,718	619,704	1,673	826	4,353	112,631
Solids Flowrate (lb/hr)	0	0	0	0	0	0	0	0	0	0
Temperature (°F)	240	100	488	1,706	650	1,780	100	100	100	100
Pressure (psia)	325	265	304	375	615	355	600	600	120	50
Stream Density (lb/ft3)	56.237	2.138	42.330	0.219	1.022	0.183	0.197	0.197	0.040	43.056
Liquid Vol @ 60°F (ft3/hr)	---	---	---	---	---	---	---	---	---	2,533.89
Molecular Weight	18.02	44.01	534.24	13.65	18.02	12.44	2.02	2.02	2.02	104.30

**Table 3-1 Process Stream Compositions, Temperatures, Pressures, and Flows
(Continued)**

	21	22	23	24	25	26	27	27
V-L Mole Fraction	F-T Liquids	F-T Liquids	Naphtha	Diesel	FG	FG	FG	Air
H2	0	0	0	0	0.309590	0.309590	0.309590	0
N2	0	0	0	0	0.354482	0.354482	0.354482	0.7823
O2	0	0	0	0	0	0	0	0.2074
H2S	0	0	0	0	0.000000	0.000000	0.000000	0
CO	0	0	0	0	0.043922	0.043922	0.043922	0
CO2	0	0	0	0	0.004542	0.004542	0.004542	0.000316
H2O	0	0	0	0	0.000817	0.000817	0.000817	0.010090
NH3	0	0	0	0	0	0	0	0
COS	0	0	0	0	0	0	0	0
CH4	0	0	0	0	0.181692	0.181692	0.181692	0
C2H4	0	0	0	0	0.010455	0.010455	0.010455	0
C2H6	0	0	0	0	0.007241	0.007241	0.007241	0
C3H6	0	0	0	0	0.026495	0.026495	0.026495	0
C3H8	0	0	0	0	0.016282	0.016282	0.016282	0
IC4H8	0	0	0	0	0.001108	0.001108	0.001108	0
NC4H8	0	0	0	0	0.021047	0.021047	0.021047	0
IC4H10	0	0	0	0	0.008609	0.008609	0.008609	0
NC4H10	0	0	0	0	0.013524	0.013524	0.013524	0
C5H10	0	0	0.114438	0	0.000021	0.000021	0.000021	0
NC5H12	0	0	0.083494	0	0.000006	0.000006	0.000006	0
IC5H12	0	0	0.056401	0	0.000001	0.000001	0.000001	0
C6H12	0	0	0	0	0.000016	0.000016	0.000016	0
NC6H14	0	0	0.156874	0	0.000005	0.000005	0.000005	0
IC6H14	0	0	0.081919	0	0	0	0	0
C7H14	0	0	0	0	0.000013	0.000013	0.000013	0
C7H16	0	0	0	0	0.000006	0.000006	0.000006	0
C8H16	0	0	0	0	0.000012	0.000012	0.000012	0
C8H18	0	0	0	0	0.000005	0.000005	0.000005	0
C9H18	0	0	0	0	0.000010	0.000010	0.000010	0
C9H20	0	0	0	0	0.000004	0.000004	0.000004	0
C10H20	0	0	0	0	0.000008	0.000008	0.000008	0
C10H22	0	0	0	0	0.000004	0.000004	0.000004	0
C11-C20 Olefins	0.584637	0	0	0	0.000032	0.000032	0.000032	0
C11-C20 Paraffins	0.250560	0	0	0	0.000014	0.000014	0.000014	0
C7-300HC	0	0	0.173525	0	0	0	0	0
3-350HC	0	0	0.045725	0	0	0	0	0
350-5HC	0	0	0	0.264095	0	0	0	0
500+HC	0	0	0	0.385993	0	0	0	0
C7-300HT	0	0	0.233268	0	0	0	0	0
3-350HT	0	0	0.054356	0	0	0	0	0
350-5HT	0	0	0	0.240675	0	0	0	0
500+HT	0	0	0	0.109238	0	0	0	0
OXVAP	0	0	0	0	0.000003	0.000003	0.000003	0
OXHC	0.1648034	0	0	0	0.000017	0.000017	0.000017	0
OXH2O	0	0	0	0	0.000012	0.000012	0.000012	0
C21 - C29 Paraffin/Olefin Mix	0	0.2726447	0	0	0.000004	0.000004	0.000004	0
C30+Waxes	0	0.690360	0	0	0	0	0	0
Total	1.0000	1.0000	1.0000	1.0000	1.0000	1.0000	1.0000	1.0000
V-L Flowrate (lbmol/hr)	594	522	2,084	1,395	13,825	11,742	11,742	170,654
V-L Flowrate (lb/hr)	104,871	322,438	221,965	315,241	273,880	232,621	232,621	4,923,362
Solids Flowrate (lb/hr)	0	0	0	0	0	0	1	1
Temperature (°F)	100	100	128	236	88	88	385	59
Pressure (psia)	50	50	40	20	20	20	460	15
Stream Density (lb/ft3)	46.129	51.397	40.769	43.599	0.067	0.067	0.999	0.075
Liquid Vol @ 60°F (ft3/hr)	2,169.77	6,187.43	5,187.10	6,508.06	---	---	---	---
Liquid Vol @ 60°F (bbl/day)	9,275	26,449	22,173	27,819				
Molecular Weight	176.49	617.86	106.52	226.04	19.81	19.81	19.81	28.85

3.2.3 Performance Summary

Table 3-2 summarizes the plant power output, including auxiliary load, for the facility at design capacity.

Table 3-2 Plant Performance Summary

Plant Output		
Gas Turbine Power	250,700	kW _e
Steam Turbine Power	401,253	kW _e
Total	651,953	kW_e
F-T Liquids Production		
F-T Liquids Production	49,992	bbl/day
Auxiliary Load		
Coal Handling	370	kW _e
Coal Milling	9,530	kW _e
Coal Slurry Pumps	2,290	kW _e
Slag Handling and Dewatering	4,890	kW _e
Air Separation Unit Auxiliaries	1,000	kW _e
Air Separation Unit Main Air Compressor	276,135	kW _e
Oxygen Compressor	50,872	kW _e
Syngas Compressor	22,763	kW _e
Fuel Gas Compressor	24,709	kW _e
CO2 Compressor, Gasifier Section	33,950	kW _e
CO2 Compressor, F-T Section	43,156	kW _e
Syngas Recycle Blower	5,215	kW _e
Tail Gas Recycle Blower	2,205	kW _e
All F-T Processes	19,207	kW _e
Boiler Feedwater Pumps	6,289	kW _e
Condensate Pump	118	kW _e
Flash Bottoms Pump	809	kW _e
Circulating Water Pump	8,870	kW _e
Cooling Tower Fans	2,010	kW _e
Scrubber Pumps	1,011	kW _e
Double Stage Selexol Plant Auxiliaries	7,200	kW _e
Claus Plant Auxiliaries	200	kW _e
Miscellaneous Balance-of-Plant	3,000	kW _e
Transformer Losses	1,900	kW _e
Total Net Auxiliary Load	527,699	kW_e
Plant Performance		
Net Plant Power	124,254	kW _e
Coal Feed Flowrate	2,044,393	lb/hr
Thermal Input ¹	6,989,714	kW _t
Elemental Sulfur Production	612	tons/day
Condenser Duty	2,135	MMBtu/hr

¹ HHV of as-received Illinois No. 6 coal is 11,666 Btu/lb.

3.2.4 F-T Output Summary

The 2,510,720 lb/hr of clean syngas feed to the F-T plant produces a total of 49,992 bbl/day of liquid products. The product stream is separated into naphtha and distillate pools. The liquid products are further characterized by carbon numbers and/or component boiling fractions. The overall compounds in the naphtha and distillate pools are shown in Table 3-3 and Table 3-4. The percentages of these components are based on standard liquid volumes.

Table 3-3 Naphtha Components

22,173 Bbl/day Naphtha Production	
Naphtha Products	Product Distribution (liquid vol.)
C5-C6 (paraffins)	38%
C7+ to 300 F boiling point	48%
300 to 350 F boiling point	14%

Table 3-4 Diesel Components

27,819 Bbl/day Diesel Production	
Diesel Products	Product Distribution (liquid vol.)
350 to 500 F boiling point	42%
500+ F boiling point	58%

The F-T diesel product is a high-value product because it is sulfur, nitrogen and aromatic free. An additive package must be added to the raw diesel pool in order to bring the fuel up to specification for sale as diesel fuel to the end-use consumer

4. PLANT DESIGN

4.1 Commercial Scale Coal-to-Liquids Facility

4.1.1 Description

The Coal-to-Liquids (CTL) plant is a stand-alone plant that is designed to produce 50,000 barrels per day of Fischer-Tropsch (F-T) liquids from a total of 24,500 TPD Illinois No.6 coal. To accommodate this level of coal feed, the plant is configured in a cluster of four gasification plants located on opposing corners of a large site, each equipped with two gasifier trains. The clean syngas from the four plants is joined in a central manifold and distributed to the central F-T plant.

Figure 4-1 illustrates the cluster plant concept.

Each gasification train cluster utilizes two oxygen-blown high pressure ConocoPhillips E-Gas™ two-stage gasifiers to produce a medium heating value syngas. Oxygen fed to the gasifiers is generated by two cryogenic air separation units (ASUs). Gas leaving the gasifiers is cooled in a fire-tube syngas cooler producing high pressure steam. The cooled gas is cleaned of particulate via a cyclone collector followed by a ceramic candle filter. The raw syngas is then cleaned further in a spray scrubber to remove remaining particulate and trace components. Slag captured by the syngas scrubber is recovered in a slag recovery unit.

The gas goes through a series of additional gas coolers and cleanup processes including a COS hydrolysis reactor, an activated carbon bed for mercury removal, and a two-stage Selexol Acid Gas Removal (AGR) system. H₂S is preferentially removed from the cool, particulate-free gas stream by a Selexol process, producing a concentrated CO₂ product stream. The stripped H₂S stream goes to a Claus plant to produce elemental sulfur. CO₂ is removed from the syngas in the second stage of the Selexol absorber. The stripped CO₂ is dehydrated and compressed to 2,200 psia for pipeline transport off-site.

Clean syngas leaving the two-stage Selexol process contains <1ppm total sulfur. The sulfur level is further reduced to <1 ppb using a zinc oxide sulfur polishing bed. Off gas from the F-T reactors is recycled to maximize liquid production. CO₂ is removed from the F-T process recycle loop, dehydrated and compressed to 2,200 psia. The F-T process generates 50,000 barrels of hydrocarbon liquids per day, consisting of both naphtha and diesel fractions. The products are upgraded through hydrotreating and hydrocracking to a commercial grade diesel fuel and a stabilized naphtha. Additives for improving the pour point, lubricity, stability, and corrosion control are used to convert the diesel fraction to a commercial-grade diesel fuel. The naphtha is sent to a petroleum refinery for upgrading.

The off gas from the F-T process is compressed and used to fuel three GE 6FA combustion turbines, producing a total of 251 MWe. Hot flue gas from the turbines passes through HRSGs generating high pressure steam that, along with steam generated

by cooling the syngas and by heat recovered from the F-T reactors, is fed to a multi-stage steam turbine to generate an additional 401 MWe of electric power.

Figure 4-1 Cluster Plant Process Diagram

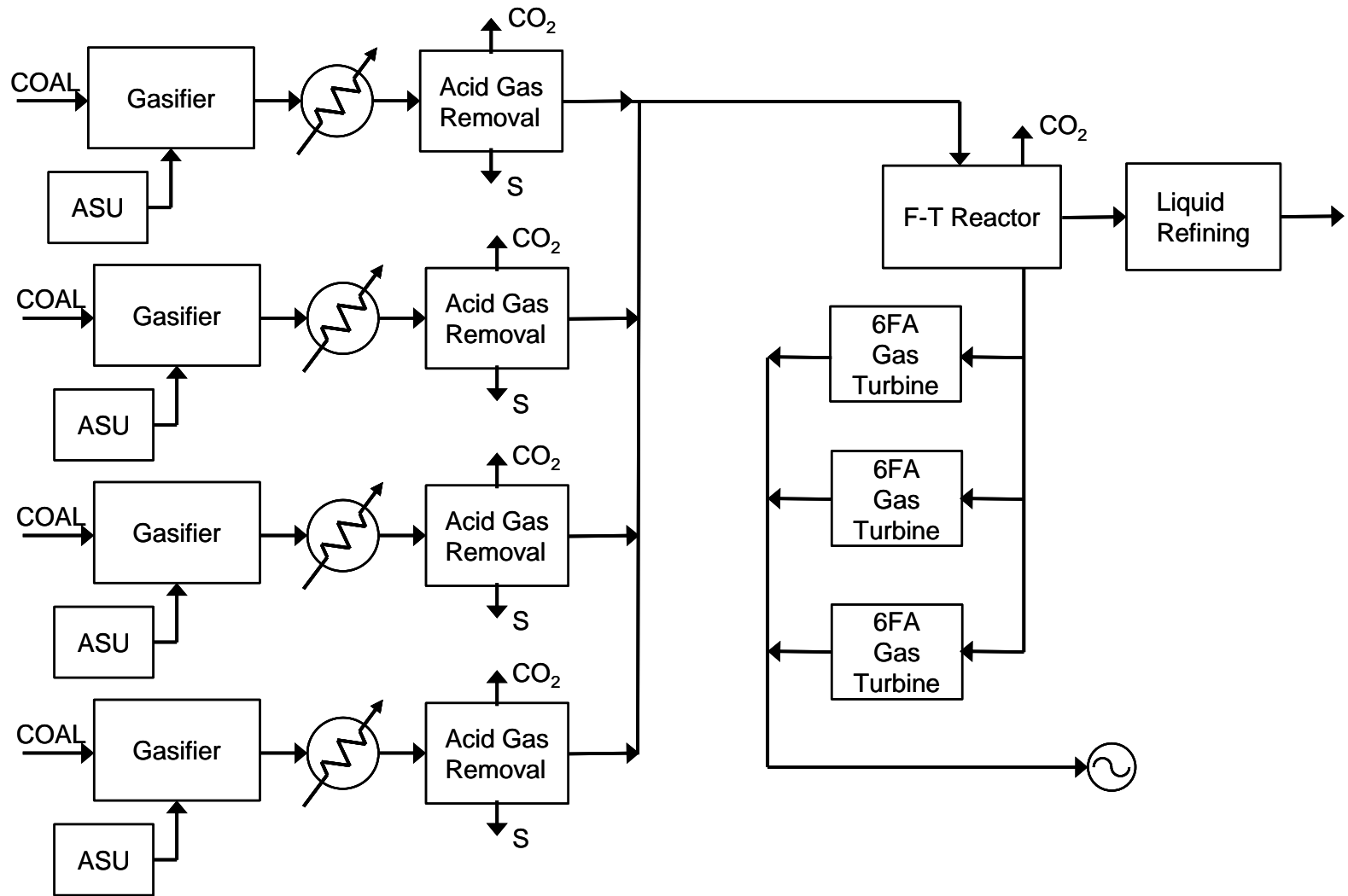

General Description of the Process Systems

The following sections describe the process in more detail.

Coal Grinding and Slurry Preparation

Coal is fed onto a conveyor by vibratory feeders located below each coal silo. The conveyor feeds the coal to an inclined conveyor that delivers the coal to the rod mill feed hopper. The feed hopper provides a surge capacity of about two hours and contains two hopper outlets. A vibrating feeder on each hopper outlet supplies the weigh feeder, which in turn feeds a rod mill. Each rod mill is sized to process 60% of the coal feed requirements of the gasifier. The rod mill grinds the coal and wets it with treated slurry water transferred from the slurry water tank by the slurry water pumps. The coal slurry is discharged into the rod mill product tank, and then the slurry is pumped from the rod mill product tank to the slurry storage and slurry blending tanks.

The coal grinding system is equipped with a dust suppression system consisting of water sprays aided by a wetting agent. All of the tanks have vertical agitators to keep the coal slurry solids suspended.

The equipment in the coal grinding and slurry preparation system is fabricated of materials appropriate for the abrasive environment present in the system. The tanks and agitators are rubber lined. The pumps are either rubber-lined or hardened metal to minimize erosion. Piping is fabricated of high-density polyethylene (HDPE).

Gasification

The E-Gas™ two-stage coal gasification technology features an oxygen-blown, entrained flow, refractory lined gasifier with continuous slag removal. A 63 wt% dry coal/water slurry is injected into the gasifier with a 78/22 percent split to the primary and secondary stages, respectively. The slurry reacts with oxygen in the primary stage at about 2,500°F and 500 psia. The coal undergoes partial combustion, releasing heat that causes the gasification reactions to proceed very rapidly and the ash to fuse and flow. A turnkey, dedicated air separation unit supplies oxygen of 95 percent purity to the gasifier.

The primary gasification zone operates above the ash fusion temperature of 2,200 to 2,500°F, thereby ensuring the flow and removal of molten slag. This temperature is maintained by a controlled oxygen feed. All of the oxygen is used in the first stage in exothermic partial oxidation/gasification reactions. The molten ash exits through a tap hole at the bottom of the primary stage into a water quench, forming an inert vitreous slag. The molten slag is quenched in water and removed by a novel continuous-pressure letdown/dewatering system. Gaseous products from the primary zone flow upward into the second gasification zone, a vertical refractory-lined vessel.

The remaining 22 percent of preheated slurry is injected in the secondary zone of the gasifier to achieve a full slurry quench. None of the raw fuel gas stream is recycled to promote quenching.

Use of the second stage of gasification is a method for both heating value enhancement and raw syngas cooling. In the secondary zone, hot gaseous products from the primary zone provide the thermal energy required to heat and gasify the atomized slurry. These gasification reactions are endothermic and considerably decrease the sensible heat content of the primary zone gases resulting in quench of the gasification reactions. As a result, the exit temperature of the secondary zone, around 1,900°F, is much lower than that of the primary zone.

Char produced in the secondary gasification zone leaves the gasifier entrained in the fuel gas stream. Combined downstream cyclone and candle filter particulate control devices remove the char from the fuel gas stream for return to the gasifier first stage.

Raw Gas Cooling

Hot raw gas from the secondary gasification zone exits the gasifier at 500 psia and 1,900°F. This gas stream is cooled to approximately 700°F in a fire-tube boiler. The waste heat from this cooling is used to generate high-pressure steam. Boiler feedwater on the outside of the tubes is saturated, and then steam and water are separated in a steam drum. This steam then forms part of the general heat recovery system that provides steam to the steam turbine.

Particulate Removal

A cyclone and a ceramic candle filter in series are used to remove any particulate material exiting the secondary gasification zone. This material, char and fly ash, is recycled back to the gasifier. The filter is comprised of an array of ceramic candle elements in a pressure vessel. The filter is cleaned by periodically back pulsing it with fuel gas to remove the fines material. Raw gas exits the candle filter at 700°F and 450 psia. Below 1,000°F a large portion of the alkali and volatile metals will condense on particulates or be captured by the filter element itself.

Gas Scrubbing

The “sour” gas leaving the particulate filter system consists mostly of hydrogen, CO₂, CO, water vapor, nitrogen, and smaller quantities of methane, carbonyl sulfide (COS), H₂S, and NH₃.

The cooled syngas at 700°F enters the scrubber for particulate removal. The quench scrubber washes the syngas in a counter-current flow in two packed beds. After leaving the scrubber, the gas has a residual soot content of less than 1 mg/m³. The quench scrubber removes traces of entrained particles, principally unconverted carbon, slag, and metals. The quench scrubber also removes soluble trace contaminants such as NH₃, HCN and halide compounds. The bottoms from the scrubber are sent to the slag removal and handling system for processing. Sour water from the scrubber is stripped of sour gas and treated for recycle or discharge.

Sour Water Stripper

The sour water stripper removes NH_3 , SO_2 , and other impurities from the waste stream of the scrubber. The sour gas stripper consists of a sour drum that accumulates sour water from the gas scrubber and condensate from syngas coolers. Sour water from the drum flows to the sour stripper, which consists of a packed column with a steam-heated reboiler. Sour gas is stripped from the liquid and sent to the sulfur recovery unit. Remaining water is sent to wastewater treatment.

Mercury Removal

Mercury is removed by packed beds of sulfur-impregnated carbon similar to what has been used at Eastman Chemical's gasification plant. Dual beds of sulfur-impregnated carbon with approximately a 20-second superficial gas residence time achieve 95% mercury reduction in addition to removal of other volatile heavy metals such as arsenic.

Acid Gas Removal

A feature of this plant configuration is that H_2S and CO_2 are removed within the same process system, the Selexol unit. The purpose of the Selexol unit is to preferentially remove H_2S as a product stream and then to remove the remaining H_2S and a fraction of the CO_2 . This is achieved in the double-stage Selexol unit.

Cool, dry, and particulate-free syngas enters the first absorber unit at approximately 100°F and 372 psia. In this absorber, H_2S is preferentially removed from the syngas stream by "loading" the lean Selexol solvent with CO_2 . The solvent, saturated with CO_2 , preferentially removes H_2S . The rich solution leaving the bottom of the absorber is regenerated in a stripper by condensing low-pressure steam in a reboiler.

Sweet fuel gas flowing from the first absorber is cooled and routed to the second absorber unit. In this absorber, the gas is contacted with "unloaded" lean solvent. The solvent removes approximately 96 percent of the CO_2 from the syngas stream going to the F-T reactor and also removes most of the remaining H_2S . A CO_2 balance is maintained by hydraulically expanding the CO_2 -saturated rich solution and then flashing CO_2 vapor from the liquid at reduced pressure. The stripped solution is then regenerated in the reboiler to produce sulfur-rich gas for feed to the Claus unit. Sweet gas from the second absorber is polished in a zinc oxide bed to reduce sulfur content in the F-T feed to <1 ppb.

CO₂ Compression

CO_2 is recovered both from each Selexol plant reabsorber at 250 psia and flashed from the rich solution at three pressures. Approximately 20% of the CO_2 is flashed off at 300 psia, 25% at 160 psia and the rest at 50 psia. The low-pressure CO_2 stream is "boosted" to 170 psia and then combined with the 160 psia CO_2 stream. The higher pressure CO_2 streams are admitted to the compressor at the appropriate pressures. The combined flow is then compressed to 2,200 psia in a multiple-stage, intercooled compressor to supercritical conditions. During compression, the CO_2 stream is dehydrated to -40°F

with triethylene glycol. The virtually moisture-free supercritical CO₂ steam is then ready for pipeline transport.

Claus Unit

Acid gas from the each Selexol stripper unit is routed to the associated Claus plant. The Claus plant partially oxidizes the H₂S in the acid gas to elemental sulfur. About 12,700 lb/hr of elemental sulfur is recovered. This value represents an overall sulfur recovery efficiency of 99.6 percent.

Acid gas from the Selexol unit is preheated to 450°F. A portion of the acid gas along with all of the sour gas and oxidant are fed to the Claus furnace. In the furnace, H₂S is catalytically oxidized to SO₂ using 95% pure oxygen. A furnace temperature greater than 2,450°F must be maintained in order to thermally decompose all of the NH₃ present in the sour gas stream.

Three preheaters and three sulfur converters are used to obtain a per-pass H₂S conversion efficiency of approximately 97.8%. In the furnace waste heat boiler, 650 psia steam is generated. This steam is used to satisfy all Claus process preheating and reheating requirements as well as steam to the medium-pressure steam header. The sulfur condensers produce 50 psig steam for the low-pressure steam header.

Air Separation Unit (ASU)

Each ASU is designed to produce a nominal output of 5,200 TPD of 95 mole % O₂ for use in the gasifier and Claus plant. The ASU is designed with two production trains. The air compressor is powered by an electric motor. Approximately 10,000 TPD of nitrogen are also recovered, compressed, and used as a diluent in the gas turbine combustors to retard NO_x formation.

The air feed to the air separation unit is supplied from a stand-alone air compressor. The filtered air is then compressed in the centrifugal compressor, with intercooling between each stage. The air stream is cooled and then fed to an adsorbent-based pre-purifier system.

The air from the pre-purifier is then split into three streams. About 70% of the air is fed directly to the cold box. About 25 to 30% of the air is compressed in an air booster compressor. This boosted air is then cooled in an aftercooler against cooling water before it is fed to the cold box. About 5% of the air is fed to a turbine driven, single stage, centrifugal booster compressor. This stream is cooled in a shell and tube aftercooler against cooling water before it is fed to the cold box.

All three air feeds are cooled in the cold box to cryogenic temperatures against returning product oxygen and nitrogen streams in plate-and-fin heat exchangers. The large air stream is fed directly to the first distillation column to begin the separation process. The second air stream is liquefied against boiling liquid oxygen before it is fed to the distillation columns. The third, small air stream is fed to the cryogenic expander to

produce refrigeration to sustain the cryogenic separation process. The work produced from the expansion is used to power the turbine booster compressor.

Inside the cold box the air is separated into oxygen and nitrogen products. The oxygen product is withdrawn from the distillation columns as a liquid and is pressurized in a cryogenic pump. The pressurized liquid oxygen is then vaporized against the high-pressure air feed before being warmed to ambient temperature. The gaseous oxygen exits the cold box and is split into two streams. Essentially all of the gaseous oxygen is fed to the centrifugal compressor with intercooling between each stage of compression. The compressed oxygen is then fed to the gasification unit. A small oxygen stream is fed to the autothermal reformer in the F-T area and to the Claus plant.

Nitrogen is produced from the cold box at two pressure levels. Low-pressure nitrogen is split into two streams. A small portion of the nitrogen is used as the regeneration gas for the pre-purifiers and is vented to the atmosphere.

F-T Process

The F-T process converts the clean syngas to 50,000 barrels per day of hydrocarbon liquids per day, consisting of both naphtha and fungible diesel.

The F-T slurry-bed reactor converts the sulfur-free syngas primarily into olefinic hydrocarbons by the reaction:

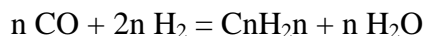

The iron-based F-T catalyst also promotes the water-gas shift reaction which produces hydrogen for the F-T synthesis reaction.

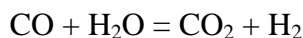

The objective of the process design is to maximize the liquid production, which results in the recycle of the unconverted syngas in the off-gas from the F-T reactor after CO₂ removal. The lighter F-T products are hydrotreated to stabilize them. The heavier F-T products are hydrocracked to lower their pour point and make a commercial diesel fuel.

The lighter hydrocarbon products that leave the slurry-bed reactor in the vapor phase are cooled and the condensed liquid is collected. The heavier hydrocarbons are removed as liquids from the reactor, separated from the suspended catalyst, cooled, and combined with the lighter products to make the liquid fuel precursors product.

In order to maintain a constant catalyst activity, there is a continual addition of fresh catalyst and a continual withdrawal of used catalyst from the slurry-bed. The fresh catalyst must be pretreated in a reducing atmosphere at an elevated temperature to activate it. The catalyst pretreating system consists of a vessel similar to the slurry-bed reactor, but without the internal cooling facilities.

The cleaned syngas from the gasification block is preheated and mixed with steam and recycle gas and fed to the slurry-bed F-T hydrocarbon synthesis reactor. The slurry-bed F-T hydrocarbon synthesis reactor converts the hydrogen and carbon monoxide to straight chain olefinic and aliphatic hydrocarbons, carbon dioxide and water. The heat of reaction is removed from the slurry-bed F-T reactor by the generation of 375 psia steam inside tubes within the slurry-bed reactor. Boiler feed water (BFW) is circulated between the steam drum and the F-T reactor to ensure that sufficient BFW always is flowing through the cooling tubes. A cyclone removes entrained catalyst particles from the vapor stream leaving the top of the F-T reactor. The vapor stream then is cooled to 40°F in four exchangers.

CO₂ from the vapor stream is captured by the absorption tower with an amine acid gas removal process. The CO₂ is regenerated from the amine-based solvent. The stream is then compressed to 2,200 psia in a multiple-stage, intercooled compressor to supercritical conditions. During compression, the CO₂ stream is dehydrated to -40°F with triethylene glycol. The virtually moisture-free supercritical CO₂ stream is then ready for pipeline transport. The vapor stream is then dehydrated and compressed for recycle to the F-T reactor.

The liquid hydrocarbon stream leaving the F-T vapor condenser is mixed with the cooled liquid hydrocarbons from the slurry-bed F-T reactor and sent for upgrading. The liquid stream leaving the slurry-bed F-T reactor passes through a hydroclone to remove a majority of the entrained catalyst particles. The catalyst-rich hydroclone bottoms go to a mixing tank from which most of it is returned to the slurry-bed reactor. A portion of the hydroclone bottoms is withdrawn and sent to the catalyst withdrawal system. Residual catalyst particles are removed from the hydroclone overhead stream in the filter system.

The catalyst-free liquid leaving the filter system is reduced in pressure and flashed. The vapor stream is further cooled to 100°F and flashed. The vapor stream is split to separate the light hydrocarbons (C₄s and lighter) which are fuel for the gas turbine. The remaining vapor is mixed with the CO₂-free vapor stream for recycle to the F-T reactor. The recycled gas to the F-T reactor passes through an autothermal reformer, in which the hydrocarbons are converted to syngas, predominantly hydrogen.

The central hydrocarbons process serves several functions. It is a collection point for the liquid and vapor streams and a separation area from which several streams exit. The resultant vapor stream is split, with most of the gas being recycled to the autothermal reformer and the F-T reactor. The rest of the gas goes through a hydrogen recovery process to produce hydrogen that is used for hydrotreating the liquids. The liquids are split into three streams: a naphtha stream, a distillate stream, and the heavy wax stream. Hydrogen is used to hydrotreat the naphtha and distillate streams, and to hydrocrack the wax into naphtha and distillate fractions.

The final liquid product consists of 44% naphtha and 56% diesel. Off gas from the liquid production processes is fuel for the combustion turbines.

Combustion Turbine Generators

The combustion turbine generators selected for this application are three General Electric MS6001FA turbines, each producing a nominal 85,000 kW for a total power production of 250,700 kW.

Steam Generation

Hot raw gas from the secondary gasification zone exits the gasifier at 500 psia and 1,900°F. This gas stream is cooled to approximately 700°F in a fire-tube boiler. The waste heat from this cooling is used to generate high-pressure steam. Boiler feedwater on the outside of the tubes is saturated, and then steam and water are separated in a steam drum. Approximately 222,000 lb/hr of saturated steam at 1,800 psia is produced from each gasifier. This steam then forms part of the general heat recovery system that provides steam to the steam turbine.

The HRSG is a horizontal gas flow, drum-type, multi-pressure design that is matched to the characteristics of the gas turbine exhaust gas. The HP drum produces steam at main steam pressure; while the IP drum produces steam for export to the cold reheat. The HRSG drum pressures are nominally 1614 psia for the HP/IP turbine sections, respectively.

Natural circulation of steam is accomplished in the HRSG by utilizing differences in densities due to temperature differences of the steam. The natural circulation HRSG provides the most cost-effective and reliable design.

Flare Stack

Each gasifier has a self-supporting, refractory-lined, carbon steel flare stack to combust and dispose of product gas during startup, shutdown, and upset conditions. The flare stack is provided with multiple pilot burners, fueled by natural gas or propane, with pilot monitoring instrumentation.

4.1.2 Major Equipment List

The major equipment list is found in Appendix A. This list is used to illustrate the four plant cluster and the overall equipment requirements for the facility.

4.1.3 Capital Costs

Total plant capital cost estimates are based on costs developed independently for prior IGCC power plants and F-T liquids facilities adjusted for the specific design criteria of this plant. Costs are based on a combination of adjusted vendor-furnished cost data and the RDS cost estimating database.

The capital costs at the Total Plant Cost level include equipment, materials, labor, indirect construction costs, engineering, and contingencies.

- Total Plant Cost or “Overnight Construction Cost” values are expressed in July 2006 dollars.
- The estimate represents current commercial offerings for the gasification technology.
- The estimates represent a complete power plant facility, including necessary integrations with existing facilities, except for the items listed below.
- The boundary limit is defined as the total plant facility within the “fence line,” including coal receiving and water supply system.
- The site is in Illinois and costs are based on a relative equipment/material/labor factor versus Gulf Coast USA.
- Costs are grouped according to a process/system oriented code of accounts; all reasonably allocable components of a system or process are included in the specific system account in contrast to a facility, area, or commodity account structure.

The capital cost, specifically referred to as Total Plant Cost (TPC) for this plant, was estimated for the categories consisting of bare erected cost, engineering and home office overheads, and fee plus contingencies. The TPC level of capital cost is the “overnight construction” estimate.

Consistent with conventional power plant practices, project contingencies were added to the TPC accounts to cover project uncertainty and the cost of any additional equipment that could result from a detailed design. The contingencies represent costs that are expected to occur. Each cost account is evaluated against the level of estimate detail and field experience to determine the amount of project contingencies.

4.1.4 Operating and Maintenance Costs

Operation and maintenance cost values have been determined on a first-year basis and subsequently analyzed over the 20-year plant book life to form a part of the economic analysis. Quantities for major consumables such as fuel and chemicals have been taken from technology-specific heat and mass balance diagrams developed for each plant application. Other consumables have been evaluated on the basis of the quantity required using reference data. Operation cost has been determined on the basis of the number of operators. Maintenance costs have been evaluated on the basis of requirements for each major plant section.

Table 4-1 and Table 4-2 show the capital and operating costs for the CTL plant. The accuracy of the results presented herein conforms to an AACE Estimate Class 5: Concept Screening. These results form the basis for the Economic Analysis described in Section 5.

Table 4-1 Concept 1 - Total Plant Cost Summary

		Client: DEPARTMENT OF ENERGY				Report Date: 10-Dec-06				
		Project: NETL Coal To Liquids Study - Illinois				TOTAL PLANT COST SUMMARY				
		Activity 1								
		Case: E-Gas Design for Fischer-Tropsch (No Refinery, No Sequestration)								
		Plant Size: 125.254 MW,net		Estimate Type: Conceptual		Cost Base (July) 2006 ; \$x1000				
		50,000 FT Liquids bbl/day								
Acct No.	Item/Description	Equipment Cost	Material Cost	Labor		Bare Erected Cost \$	Eng'g CM H.O.& Fee	Contingencies		TOTAL PLANT COST \$
				Direct	Indirect			Process	Project	
1	COAL & SORBENT HANDLING	40,655	8,404	35,203	2,464	86,727	6,938		23,416	117,081
2	COAL-WATER SLURRY PREP & FEED	62,767	13,721	51,844	3,629	131,962	10,557		35,630	178,148
3	FEEDWATER & MISC. BOP SYSTEMS	12,310	11,530	12,929	905	37,674	3,014		10,172	50,859
4	GASIFIER & ACCESSORIES									
4.1	Gasifier & Auxiliaries	270,951	128,128	223,895	15,673	638,647	51,092		172,435	862,173
4.2	Syngas Cooling	w/4.1	w/4.1	w/4.1						
4.3	ASU/Oxidant Compression	287,187		w/equip.		287,187	22,975		77,540	387,702
4.4-4.9	Other Gasification Equipment	46,865	57,900	65,414	4,579	174,757	13,981		47,184	235,922
	Subtotal 4	605,002	186,028	289,309	20,252	1,100,591	88,047		297,159	1,485,797
5A	GAS CLEANUP	164,720	18,909	169,318	11,852	364,800	29,184		98,496	492,480
5b	FISCHER-TROPSCH SYSTEMS	326,877	48,364	39,571	2,770	417,582	33,407	112,747	140,934	704,669
6	COMBUSTION TURBINE GENERATOR									
6.1	Combustion Turbine Generator	69,575		2,445	171	72,191	5,775		19,492	97,458
6.2-6.9	Combustion Turbine/Generator Accessories		437	387	27	851	68		230	1,149
	Subtotal 6	69,575	437	2,832	198	73,042	5,843		19,721	98,607
7	HRSG, DUCTING & STACK									
7.1	Heat Recovery Steam Generator	20,035		2,445	171	22,651	1,812		6,116	30,579
7.2-7.9	HRSG Accessories, Ductwork and Stack	1,942	1,320	1,558	109	4,929	394		1,331	6,655
	Subtotal 7	21,977	1,320	4,003	280	27,581	2,206		7,447	37,234
8	STEAM TURBINE GENERATOR									
8.1	Steam TG & Accessories	45,258		6,037	423	51,718	4,137		13,964	69,819
8.2-8.9	Turbine Plant Auxiliaries & Steam Piping	12,080	1,195	9,025	632	22,933	1,835		6,192	30,959
	Subtotal 8	57,339	1,195	15,062	1,054	74,651	5,972		20,156	100,778
9	COOLING WATER SYSTEM	13,603	9,129	12,852	900	36,484	2,919		9,851	49,254
10	ASH/SPENT SORBENT HANDLING SYS	47,228	26,435	44,694	3,129	121,486	9,719		32,801	164,006
11	ACCESSORY ELECTRIC PLANT	12,858	6,162	15,567	1,090	35,676	2,854		9,633	48,163
12	INSTRUMENTATION & CONTROL	19,899	3,238	16,063	1,124	40,324	3,226		10,888	54,438
13	IMPROVEMENTS TO SITE	6,302	3,998	14,961	1,047	26,308	2,105		7,103	35,515
14	BUILDINGS & STRUCTURES		8,918	14,464	1,012	24,395	1,952		6,587	32,933
	TOTAL COST	\$1,461,113	\$347,788	\$738,673	\$51,707	\$2,599,281	\$207,943	\$112,747	\$729,993	\$3,649,964

Table 4-2 Concept 1 - Operating and Maintenance Expenses

INITIAL & ANNUAL O&M EXPENSES				Cost Base (July)	2006
Illinois 50,000 BPD CTL Plant (Analysis 1-1)	12/12/2006	Heat Rate-net(Btu/kWh):			N/A
		MWe-net:			125,254
		Capacity Factor: (%)			85.0
OPERATING & MAINTENANCE LABOR					
<u>Operating Labor</u>					
Operating Labor Rate(base):	34.78	\$/hour			
Operating Labor Burden:	30.00	% of base			
Labor O-H Charge Rate:	25.00	% of labor			
Operating Labor Requirements(O.J.)per Shift:	<u>1 unit/mod.</u>		<u>Total Plant</u>		
Skilled Operator	4		16		
Operator	20		80		
Foreman	4		16		
Lab Tech's, etc.	8		32		
TOTAL-O.J.'s	36		144		
					Annual Cost
					\$
Annual Operating Labor Cost(calc'd)					\$57,034,748
Maintenance Labor Cost(calc'd)					\$77,978,439
Administrative & Support Labor(calc'd)					\$14,258,687
Maintenance Material Cost(calc'd)					\$51,985,626
TOTAL FIXED OPERATING COSTS					\$201,257,499
VARIABLE OPERATING COSTS					
<u>Consumables</u>					
	<u>Consumption</u>		<u>Unit</u>	<u>Initial</u>	
	<u>Initial</u>	<u>/Day</u>	<u>Cost</u>	<u>Cost</u>	
Water(/1000 gallons)	0	21,400	1.20	\$0	\$7,967,220
Chemicals					
MU & WT Chem.(lbs)	227,904	32,556	0.19	\$42,588	\$1,887,463
Carbon (Mercury Removal) (lb.)	217,712	392	0.90	\$195,941	\$109,456
COS Catalyst (lb)	494,800	272	0.91	\$450,268	\$76,793
Selexol Solution (gal.)	445,320	100	14.40	\$6,412,608	\$446,760
MDEA Solution (lb)	0	0	0.89	\$0	\$0
Zinc Oxide	494,800	60	0.20	\$98,960	\$3,723
Ammonia (28% NH3) ton	0	0	228.00	\$0	\$0
				Subtotal Chemicals	\$7,200,365
					\$2,524,196
Other					
Supplemental Fuel(MBtu)	0	0	0.00	\$0	\$0
SCR Catalyst Replacement	w equip	0	9,480	\$0	\$0
Emission Penalties	0	0	0.00	\$0	\$0
				Subtotal Other	\$0
					\$0
Waste Disposal					
Spent Mercury Catalyst (lb.)	0	392	0.38	\$0	\$46,215
Flyash (ton)	0	0	18.00	\$0	\$0
Bottom Ash(ton)	0	2,470	18.00	\$0	\$13,793,715
				Subtotal Solid Waste Disposal	\$0
					\$13,839,930
By-products & Emissions					
Sulfur(tons)	0	612	-25.00	\$0	(\$4,746,825)
Power Production, MWh	0	3,006	-35.00	\$0	(\$32,641,403)
				Subtotal By-Products	\$0
					(\$37,388,228)
TOTAL VARIABLE OPERATING COSTS					(\$13,056,882)
FUEL (tons)	0	24,533	33.33	\$0	\$253,662,383

5. FINANCIAL ANALYSIS

The results of the plant design and cost estimates for the Illinois coal-to-liquids plant was used as the basis for the financial analysis. The analysis strived to reflect the overall economics of the plant by considering the capital cost, operating requirements, and all major products. A simplified schematic of the plant inputs and outputs used for financial modeling purposes can be seen in Figure 5-1 below:

Figure 5-1 Key Plant Inputs/Outputs, Nominal 50,000 BBL/Day Illinois F-T Liquids Plant

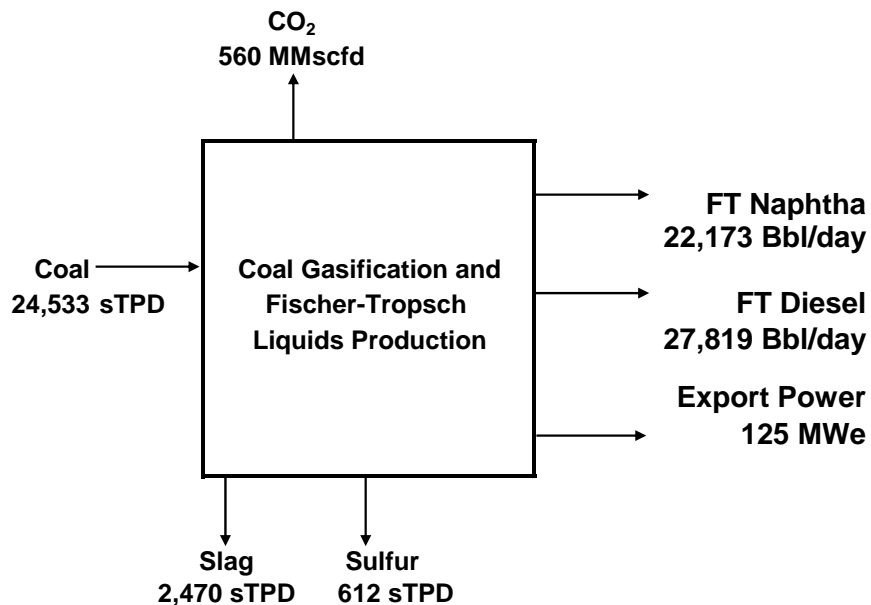

The key results desired from the analysis are the project return on equity investment, discounted cash flow, and identification of key model sensitivities. An important sensitivity was varying the F-T liquids value to show the financial results from a number of potential crude oil price scenarios. In addition, the impact of recent federal policies intended to support coal-to-liquids plants is also addressed. The model used to perform this work is the Nexant-developed Power Systems Financial Model, Version 5.0.5. This model was originally developed in May 2002 and has since been modified to incorporate additional functionality. The model has been used in numerous gasification studies, and is now the standard used by NETL for gasification project financial analysis. It is a robust discounted cash flow model that takes into account all major financial and scenario assumptions in developing the key economic outputs.

5.1 Methodology

To develop appropriate financial assumptions for the facility, different sources were consulted. Since this is a preliminary analysis for the potential of the facility, the analysis strived to mirror standard assumptions used for facilities of this size and risk profile. The

main sources used for input into the financial model were NETL's "Quality Guidelines for Energy System Studies," team and reviewer inputs, previous gasification optimization studies performed by Nexant² for NETL, and published data for commodity prices. Details of the financial assumptions can be found in Appendix B. A few of the major assumptions and some of the areas that were explored via sensitivity analysis are listed below:

- A **26% project contingency** applied across the entire plant to reflect the uncertainty in the cost estimate at this phase of the analysis.
 - In addition, a **process contingency of 25%** was assigned to the F-T liquids synthesis unit to reflect greater cost and design uncertainty relative to the rest of the plant
- **85% plant availability**
- **40% tax rate**
- **48-month construction period**
- **30-year plant life**
- **55:45 debt to equity ratio** for project financing, **8% cost of capital**. Since additional financing analysis was performed, the basis was made as consistent as possible with recent finance analysis specific to large coal gasification plants³ and NETL coal-to-liquids studies.
- **3% cost escalation** on all plant outputs, 2% on the price of coal

Specific plant performance and operating data were entered into the model from the design basis. The material and energy balance provided the power output, production rate of F-T liquids, sulfur generation, coal feed requirements, and all other input/output streams. The plant EPC cost used for the model analysis was determined from installed cost estimates for all major unit operations, off-sites, and balance-of-plant items.

The commodity price inputs are from recent forecast estimates, team analysis, and utility information. The value for steam coal from Department of Energy's Annual Energy Outlook 2007 (AEO 2007) was used to estimate the coal price⁴. Adjusted for the base year used in the financial model, the value applied was \$1.57/MMBTU, or \$36.63/ton for Illinois #6 coal. AEO 2007 numbers were also used to develop the \$52/MWh export electricity price. This number is derived from estimates specific to the Illinois industrial power sector. The slag and sulfur produced are assumed to have little value, \$0/ton for slag and \$10/ton for sulfur, based on previous coal gasification studies performed by the team. Finally, the carbon dioxide emitted from the plant was given no value. Sensitivity analysis was performed on all

² Tasks 1 and 2, *Gasification Plant Cost and Performance Optimization* study, DOE Contract number DE-AC26-99FT40342, September 2003.

³ Rosenberg, W., Walker, M., Alpern, D., "The 3 Party Covenant – A Path to IGCC Financing", presented at the 2004 Gasification Technologies Conference, Washington, DC, October 2004.

⁴ See Table A3, "Energy Prices by Sector and Source", available at <http://www.eia.doe.gov/oiaf/aeo/pdf/appa.pdf>

commodity inputs with the exception of carbon dioxide to show their relative impact if these numbers change from the base case. Carbon dioxide impacts will be addressed in future analysis.

Volatility in petroleum product prices and differences in the quality of F-T products versus conventional transportation fuels required a different approach in estimating the liquid product values. As a starting point, the average value for diesel and gasoline in the US Midwest (data obtained for Petroleum Area Defense District (PADD) 2 from the US DOE) from January 2005 to June 2006 was used. It was assumed that the price level and behavior of the market during this timeframe would be representative of how gasoline and diesel prices would behave in the future. Modifications were made to these prices to reflect the potential values of F-T diesel and naphtha:

- For F-T diesel fuel, the wholesale PADD 2 low sulfur (LS) diesel price was directly entered into the model. Because of the additional refinement performed in the F-T plant, the F-T diesel quality should closely mirror that of LS diesel fuel ready for use in transportation. Although the F-T diesel has additional qualities (namely high cetane, low aromatics, and low sulfur) that may lead to a premium price, this assumption cannot be confirmed at this time without further market analysis.
- The F-T naphtha was valued at PADD 2 conventional gasoline minus 40 cents per gallon to account for the low octane value of the stream. Unlike the F-T diesel stream, the naphtha cannot directly be used as a transportation fuel, and will require blending or other upgrading to make it suitable for transportation use. While the low sulfur content of the stream is favorable to the gasoline pool, the low octane value will outweigh this benefit.
- Two different approaches were performed to estimate the level of discount. First, the team developed a model to reflect the cost of upgrading F-T naphtha in a refinery to allow it to be blended into the gasoline pool. The result of this analysis showed a cost of roughly 20 cents/gallon. This discount would be expected if the coal-to-liquids plant was integrated into a petroleum refinery. Another option for a stand alone producer of F-T naphtha is to sell it into the open market for either direct blending, use as a chemical feedstock, or use for other fuel purposes. Data from the AEO 2007 on kerosene type light jet fuels, as a rough proxy for the F-T naphtha cut, shows a discount of 60 cents/gallon relative to gasoline. An average of these two approaches was taken to obtain the 40 cent/gallon discount used in the financial analysis.

Preliminary model runs were performed in December 2006 after the initial estimates were developed for system configuration, plant cost, and commodity prices. The results are presented in the next section.

5.2 Results and Sensitivities

The general methodology followed for performing the financial analysis was outlined in Section 5.1. Inputs were placed into the Power Systems Financial Model Version 5.0.5 to obtain the results discussed in this section. Appendix B provides the model inputs for both cases considered.

The plant EPC cost entered into the financial model was taken from the analysis done in Sections 4.1.3 and 4.2.3. "Bare Erected Cost" was combined with the engineering and home office fees provided in the cost estimate to produce the EPC cost. On top of these costs, a ~26% project contingency, 25% process contingency on the F-T synthesis section of the plant, 2% start-up cost, and 10% owner's cost was included to reflect the total plant costs. These additional costs increase the "Total Plant Cost" reflected in Section 4 to the values that are used in the financial model calculations. The results of the financial analysis can be seen in Table 5-1 below:

Table 5-1 Financial Model Results

<i>Major Inputs</i>	
EPC Cost (\$MM)	2,807
Liquids Production (BPD)	49,992
Coal Feed Rate (TPD)	24,533
<i>Major Results</i>	
ROI (%)	19.8
NPV (\$MM, 12%)	1,543
Payback Period (Yrs)	5
Crude Oil Price for 12% ROI (\$/Bbl)	43

The base case result shows positive financial performance, with a nearly 20% return on equity investment and a net present value of over \$1.5 billion. A correlation was established between the F-T liquids value and crude oil prices to determine how changes in crude oil price would impact the ROI. A long term crude oil price of \$43/bbl would provide a 12% ROI to project investors using the base case model assumptions. Section 5.2.1 provides more information about this analysis.

Table 5-2 below breaks down the total plant cost including EPC costs, fees, start-up costs, and costs incurred from project financing. Combining the EPC costs and contingencies gives the "Total Plant Cost" shown in Section 4.

Table 5-2 Total Plant Costs

Construction/Project Cost (in Thousand Dollars)		
<u>Capital Costs</u>	<u>Category</u>	<u>Percentage</u>
EPC Costs	\$2,807,224	62%
Initial Working Capital	\$83,022	2%
Project Contingency	\$729,993	16%
Process Contingency (F-T Liquids Synthesis)	\$112,747	2%
Start-up (% of EPC Costs)	\$56,144	1%
Initial Debt Reserve Fund	\$0	0%
Owner's Cost (in thousand dollars)	\$280,722	6%
Additional Capital Cost	\$0	0%
<i>Total Capital Costs</i>	\$4,069,853	90%
<u>Financing Costs</u>		
Interest During Construction	\$384,606	8%
Financing Fee	\$73,499	2%
Additional Financing Cost	\$0	0%
<i>Total Financing Costs</i>	\$458,105	10%
Total Project Cost	\$4,527,958	100%
<u>Sources of Funds</u>		
Equity	\$2,037,581	45%
Debt	\$2,490,377	55%
Total Sources of Funds	\$4,527,958	100%

5.2.1 Performance and Cost Sensitivities

With the exception of plant feed and output rates, all financial model inputs were varied to determine the project sensitivities. Model input changes deemed to be reasonable based on previous sensitivity analysis, commodity input ranges, and team estimates were entered into the model. The range of model input variables used in the sensitivity analysis is listed in Table 5-3. The impact that these changes had on the ROI were recorded, using a +/- 25% change in the unit input as the basis for variable evaluation. The variables and their impact on the financial outputs were then ranked to determine the model inputs of highest sensitivity. Results of this analysis can be seen in Figure 5-2 below.

Table 5-3 Range of Values Used in the Sensitivity Analysis

Model Inputs	Base	(+25%) High Range	(-25%) Low Range
Delivered Coal Price (\$/ton)	36.63	46	27
Electric Tariff (\$/MWh)	52	65	39
Naphtha (\$/gallon)	1.50	1.88	1.13
Diesel (\$/gallon)	1.96	2.45	1.47
Sulfur (\$/ton)	10	12.5	7.5
EPC Cost (\$MM)	2807	3509	2105
O&M Cost (\$MM)	213.6	267.0	160.2
Loan Interest Rate (%)	8	10	6
Availability (%)	85	106	64
Project Life (Yrs)	30	38	23
Debt Financing (%)	55	69	41
Tax Rate (%)	40	50	30

Figure 5-2 Relative Sensitivities of Major Plant Inputs, +/-25%

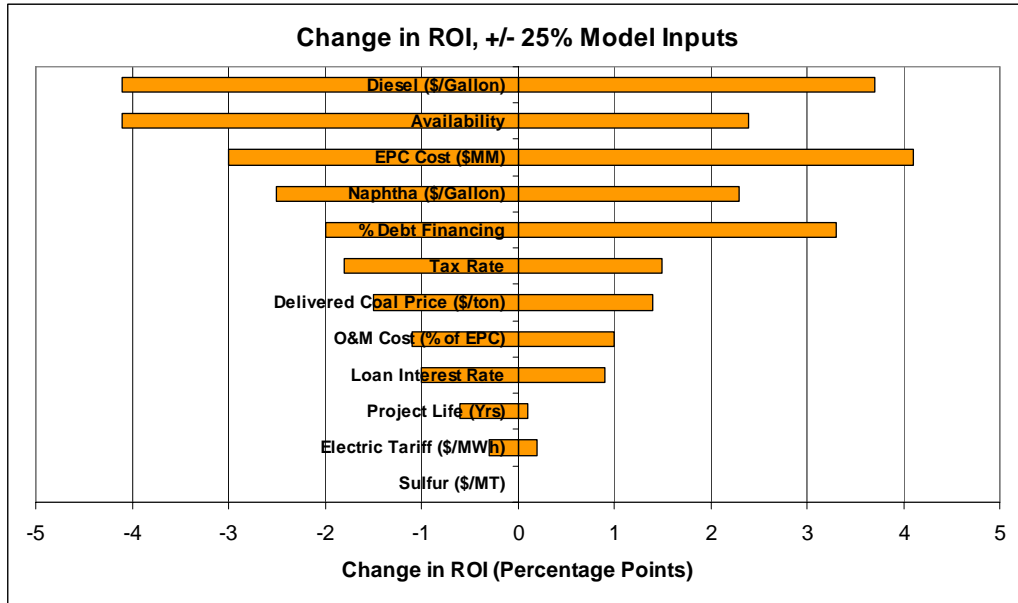

Plant availability and EPC cost were found to have a very strong impact on plant financial returns (note that availability was not allowed to exceed 100% in the figure above). This is a common sensitivity found in many gasification studies and should come as no surprise; reliable plant operation and controlling plant costs are very important to a successful project. The value of the main products, F-T naphtha and diesel, were also found to strongly impact the financial results. In fact, these variables may impact the results even more strongly once the range of potential values is taken into consideration. Naphtha and diesel prices are more volatile and less predictable than many other process variables, and are likely to vary more than the +/- 25% displayed in Figure 5-2. The amount of debt financing and tax rate used were also found to be important, although less so than plant cost, availability, and F-T liquids value. Greater investigation into policies that could impact the financial basis is explored in Section 5.2.2.

To demonstrate the potential liquids price volatility that could be witnessed during the life of the plant, historic values for West Texas Intermediate (WTI) crude oil, gasoline, and low-sulfur diesel in PADD 2 can be seen in Figure 5-3 below.

Figure 5-3 PADD 2 Petroleum Product Values⁵

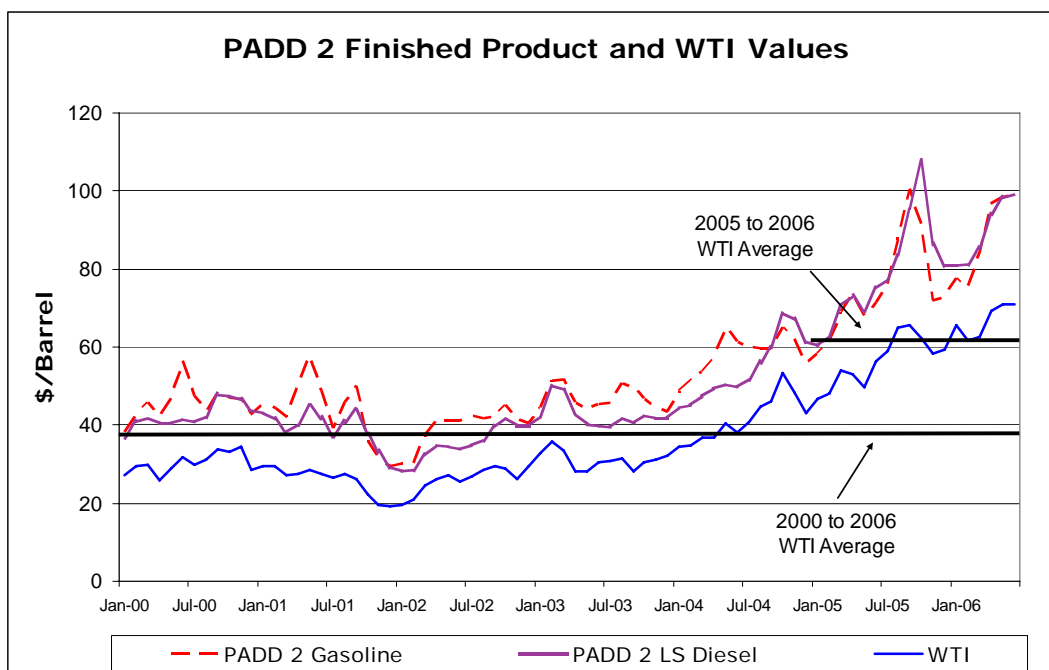

Depending on the timeframe chosen for pricing F-T liquids, the financial results of the plant can be very different. Choosing the 2005-2006 timeframe where crude oil prices are high by historic standards will lead to F-T liquids prices that are 60 to 70 cents a gallon higher when compared to the average of prices this decade. This was the basis used for the financial analysis. Recent analysis performed on the petroleum market has speculated that the 2005-2006 price average of near \$60/barrel for crude oil may represent a new basis for the market, rather than previous historic averages⁶. The impact that using a different basis for WTI price will have on plant ROI can be seen in Figure 5-4 below. A historic correlation between refined product values and WTI, adjusted to represent the value of the F-T products, was developed for the purposes of this figure.

⁵ Information from the US Department of Energy, Energy Information Agency, available at www.eia.doe.gov

⁶ Hargreaves, Steven, "Why Oil Won't Go Below \$60", Money Magazine, 2 August 2006, available at http://money.cnn.com/2006/08/01/news/economy/oil_floor/index.htm OPEC has stated that a world crude oil price of \$60/barrel is a target that they will attempt to achieve through supply controls.

Figure 5-4 Impact of Petroleum Prices on Plant ROI

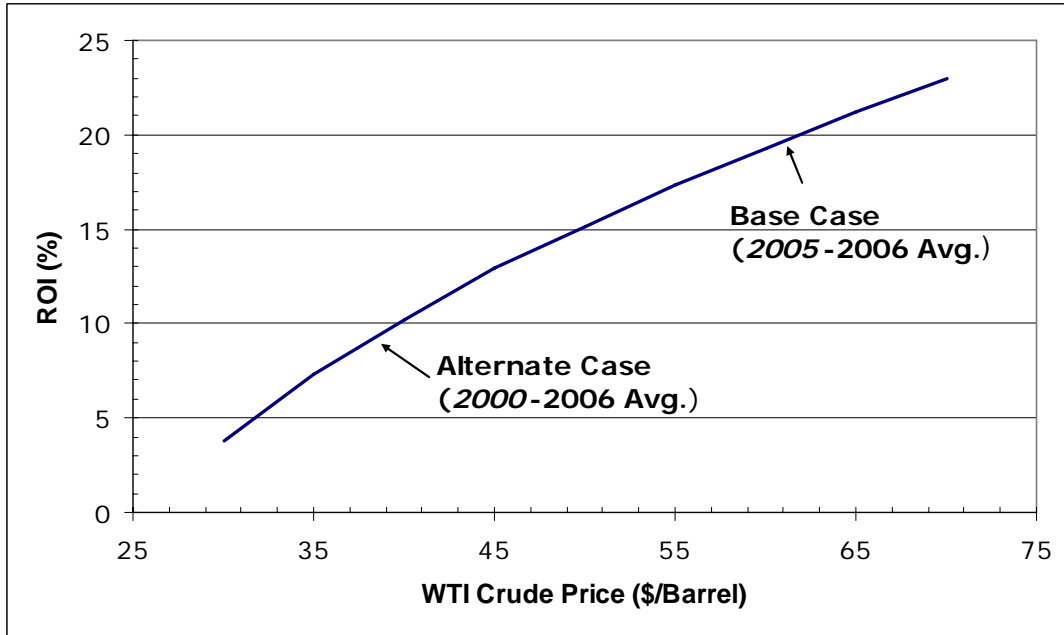

Using the 2000 to 2006 average (\$38/barrel for WTI) versus what was assumed in the base case drops the plant ROI by ~10 percentage points. Although the return in the alternative case is still nearly 10%, project developers must be comfortable with the risks inherent in the petroleum market and their exposure. Price information from specific consumers of the F-T products and future projections for petroleum product prices are key to determining if the plant will be economically viable. Discussions should be held with local refiners and product distributors to determine how they would value the F-T streams relative to crude oil, gasoline, or diesel. Once this information is obtained, more refined estimates could be made to determine if the price level necessary to make the plant economically attractive can be obtained.

As mentioned above, the plant EPC cost and availability also has a large impact on the ROI. The base case financial analysis includes a 26% project contingency plus an additional 25% process contingency on the F-T island in an attempt to estimate EPC uncertainty at this stage of the design. Because other model inputs are based on a percentage of the plant EPC cost, changes in this variable has a multiplier impact on the overall economic results. In a capital investment of this magnitude, developing the most accurate estimate for the plant cost is important to best understand project economics.

Figure 5-5 shows the relationship between process availability and project ROI.

Figure 5-5 Effect of Availability on Project ROI

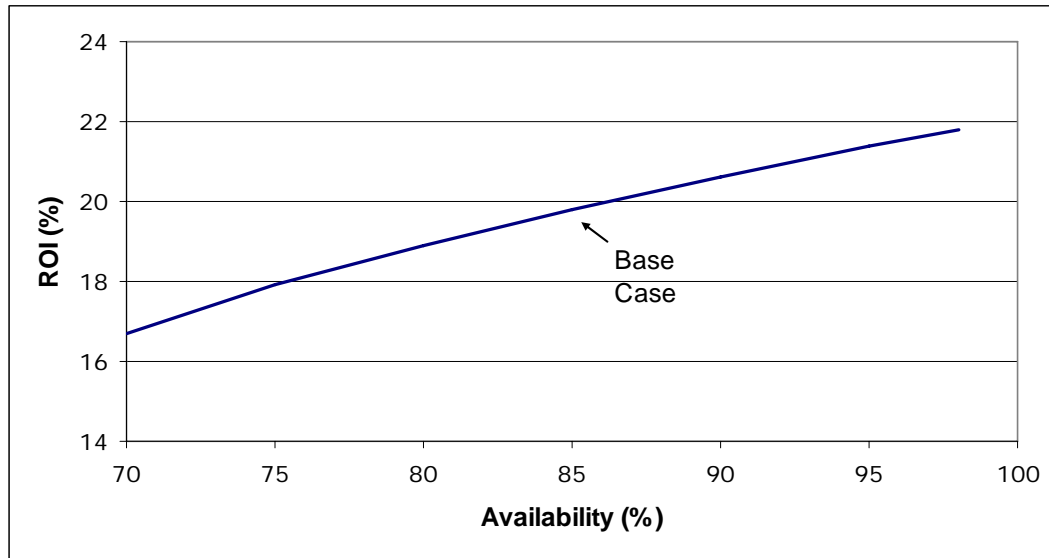

Reliable operation is very important to assure that the cost of project development and construction can be recovered. Long downtimes throughout the life of the project will hurt overall project economics given a 30-year project life. However, plant availabilities as low as 70% will still provide a plant ROI of roughly 17%, only 3 percentage points lower than the base case. This shows that concerns over gasification or F-T plant performance should not be a major hindrance to project development, since potentially acceptable rates of return can be achieved even with lower than expected availability for this plant.

Based on the analysis where key process variables were changed by 25%, it can be stated that the project finance inputs are robust on a general basis. The rates of return remain over 15% regardless of the variables changed, when using the base case values for F-T liquids. Besides EPC cost, the two items most critical to the financial analysis, availability and F-T liquids value, can vary significantly based on plant design and market conditions. These variables should be carefully examined when considering the range of financial outcomes. Other inputs, while important to a complete picture of a facility's financial potential, do not have the impact of these two factors.

5.2.2 Policy Considerations

As part of the analysis performed by the team, different financial scenarios were modeled based on policy initiatives that may support project development. The scenarios were developed through consultation with the analysis team and the project sponsors. The base case financial model was changed under each scenario to reflect the different conditions that would result from application of the policy incentives.

Three policy scenarios were considered, with each evaluated independently. While multiple incentive programs may be available that project developers could take advantage of, the point of this analysis is to show how each program impacts the economics on its own.

- 1) Subsidy on F-T Liquids – The relevant federal subsidy for liquid transportation fuels from coal is the 50 cent/gallon (\$21/barrel) incentive included in the 2005 Federal Transportation Bill (H. Res 109-203, Title XI, Section 11113(d)). Under this bill however, the credit is set to expire in 2009 well before this plant could take advantage of the potential excise tax credit. For purposes of this analysis, a case was analyzed under the assumption that these credits would be extended throughout the life of the project. A sensitivity was run with the credits expiring in 2020, as has been proposed in legislation during the 109th Congress (as an example, see S.3623, "Coal to Liquid Fuel Energy Act of 2006"). Per the updated guidelines published by the IRS, it appears that the credits can be used to reduce income taxes and will lead to a refund if the credits exceed the tax burden for that year. It is assumed that the naphtha produced will be used for transportation fuel purposes. **IMPACT: Reduce tax burden by 50 cents/gallon of F-T naphtha and diesel produced.**
- 2) Federal Loan Guarantees – Another component of EAct 2005 are a series of loan guarantees for advanced coal projects. Section 1703(c) specifically outlines benefits for gasification projects where electrical output is less than 65% of the useful product, such as an F-T plant. Loan guarantees will not only lower the interest rate used for debt financing, but could also allow a greater portion of the project to be financed through debt. Up to 80% of the project cost can be covered by loan guarantees outlined in this section of the EAct. Assumptions for the changes in each of these variables are based on the Rosenberg paper referenced earlier. **IMPACT: Interest rate on debt financing lowered from 8% to 6%, and debt/equity ratio changed to 80/20 from 55/45.**
- 3) Investment Tax Credit (ITC) – The final EAct item evaluated is the 20% investment tax credit allowed per the modifications to IRC 48B. This tax credit is applied in the first year of plant operation, and can only be applied on the first \$650MM of investment (\$130MM ITC cap). This project would not be eligible for credits under Section 48A because power is not the main project output. **IMPACT: 20% investment tax credit on the first \$650MM of total plant capital costs, reflected in the first year of plant operation.**

The results from the analysis are presented in Table 5-4. Both the ROI and NPV for a 12% discount rate are presented, along with the change from the base case.

Table 5-4 Financial Impacts on Evaluated Policies

	ROI, % (change)	NPV at 12%, \$MM (change)
Base Case	19.8 (-)	1,543 (-)
F-T Subsidies	28.7 (+8.9)	3,386 (+1,843)
Loan Guarantees	31.1 (+11.3)	2,067 (+524)
ITC	20.4 (+0.6)	1,625 (+82)

The use of loan guarantees in financing the project has the most positive impact on the plant ROI. It is the change in the debt to equity ratio, and not the change in the loan interest rate, that is responsible for the majority of the benefit. For projects with strongly positive cash flows throughout the life of the project, reducing the up front capital required by increasing the amount of debt will have a greater impact on ROI than reducing the interest payments. This also reduces the risk to equity investors by limiting their financial exposure.

Limiting exposure can be a negative in a project with very good economics. While the Loan Guarantees case has the highest ROI, the NPV is \$1.3 billion lower than the F-T Subsidies case. In the Subsidies case equity investment is at the base case level, 45%. Because of the higher equity investment, the absolute cash flow to equity investors (NPV) is significantly higher than the Loan Guarantees case. From a government standpoint, Loan Guarantees may be preferred over Subsidies due to their impact on the Treasury. Provided that the loans are repaid from project revenues, the transaction costs to the federal government are much lower than the loss of tax revenue. The risk to the government in the Loan Guarantees case is based upon the project failing; if there is no revenue stream to repay the loans, the government is saddled with repayment responsibility. The risk in the Subsidies case is the exact opposite; the government only loses tax revenue if the project succeeds.

The benefits to the project developer in the Subsidies case are very financially attractive. The case was run under the assumption that once excise tax credits had been paid, any remaining credits could be used against income tax. Specific IRS guidelines have not been established for this credit since no projects will be taking credit under the current legislation. The net tax burden if the credit is allowed for every year of project operation is \$4.9 billion, nearly \$10 billion less than the base case. Even if restrictions are placed on the subsidy, the financial returns are still very positive. Limiting the policy to the year 2020 (first 9 years of plant operation) results in a 27.9% ROI and an NPV of \$2.83 billion. Preventing plant operators from obtaining a refund if credits exceed the tax burden reduces the ROI further, to 25.2%. Subsidies are good for hedging against crude price volatility. Because of the major sensitivity that the plant has to the value of the F-T liquids, policies that reduce the price volatility risk would be of interest to project developers. Varying the subsidy based on crude price could potentially be a finer policy instrument to assist project developers without undue Treasury burden.

Relative to the other two policies considered, the ITC is only of marginal assistance to a project developer. Providing a tax credit capped at \$130MM in a project with a total investment of over \$4 billion has a small net impact. One positive of the tax credit is that it can be claimed by the developer in the first year of plant operation. Considering the discount rate used in the financial analysis, tax credits are more valuable at the beginning of the project versus being spread out over a number of years. The benefit provided is significantly less than the tax credits in the Subsidies case, leading to a much more modest impact on ROI and NPV.

6. CONCLUSIONS

This study is the first part of a series of plant design studies for commercial scale F-T plants. The conclusions and recommendations from this study feed directly into the follow on study to be conducted under activity 004 of subtask 401.01.08.

- This plant was designed to produce 22,173 bbls/day of liquid naphtha products that can be shipped to a refinery for further upgrading to commercial grade products or sold as a chemical feedstock. The plant was designed to produce 27,819 bbl/day of diesel fuel that can (with additives) be delivered to end-use customers.
- The total coal input requirement is 24,533 tons/day of Illinois #6 coal.
- The plant was designed to produce 652 MWe of gross power of which 528 MWe are used for internal loads including the air separation unit compressors which consume 276 MWe. The net plant power is 124 MWe which can be used for external electrical demand.
- Total sulfur production is 612 tons per day, and total carbon dioxide capture is 32,481 tons per day.
- The total plant cost was estimated to be \$3.65 billion. This includes \$1.49 billion for the gasification systems, \$0.70 billion for the F-T system and \$0.49 for the gas cleanup systems.
- Total capital costs including working capital, start up costs, and owners costs was \$4.07 billion. Adding allowances for financing costs results in a total project cost of \$4.53 billion.
- The financial analysis for a base case shows positive financial performance with nearly 20% return on investment and a net present value of over \$1.5 billion. A payback period of 5 years was projected.
- Plant capacity factor and EPC costs had a strong impact on the financial returns. A capacity factor reduction of 25% would lower the ROI from 20 % to 16%. An increase in EPC of 25% would reduce the ROI to 17%.
- Project viability depends heavily on crude oil price scenarios. At crude oil prices greater than \$37/barrel, the project would achieve an ROI greater than 10%. A 15% ROI is achievable for crude oil prices greater than \$47/barrel.
- State and Federal policy actions impact expected ROIs. Loan guarantees have the largest impact, increasing the ROI by more than 11 percentage points from the base case. F-T subsidies provide a 9 percentage point increase in ROI.

6.1 Recommendations for Further Study

Follow on studies in Activity 004 will consider the impact of producing only a syncrude product and the impacts of variations in carbon capture from zero to 100%. Other ideas emerged from this preliminary assessment as recommendations for follow-up studies:

- Evaluate plant performance and economics using Rectisol in place of Selexol for acid gas removal, which allows elimination of the COS hydrolysis step prior to sulfur removal.
- Evaluate plant performance and economics using a different type of gasifier, e.g., a Shell dry-feed gasifier.
- Evaluate plant performance and economics using a cobalt F-T catalyst.
- Evaluate plant performance and economics using different coal types (subbituminous and lignite).
- Evaluate plant performance and economics using the refrigerated Selexol process for sulfur removal to reduce size and cost of the sulfur recovery unit.
- Update the F-T reactor model used in this evaluation.
- Prepare a white paper on various F-T reactors and catalysts to determine design that optimizes performance and reduces costs.
- Quantify effluent discharge from the CTL plant and compare to new, stricter limits regulating discharges.
- Generate and evaluate conceptual designs that produce zero effluent discharge.

APPENDICES

APPENDIX A DETAILED EQUIPMENT LISTS

ACCOUNT 1 COAL HANDLING

ACCOUNT 1A COAL RECEIVING AND HANDLING

Equipment No.	Description	Type	Design Condition	Qty	Total Plant
1	Bottom Trestle Dumper and Receiving Hoppers	N/A	200 ton	2	8
2	Feeder	Vibratory	200 tph	2	8
3	Conveyor No. 1	54" belt	400 tph	2	8
4	Conveyor No. 2	54" belt	400 tph	2	8
5	As-Received Coal Sampling System	Two-stage	N/A	2	8
6	Reclaim Hopper	N/A	80 ton	2	8
7	Feeder	Vibratory	300 tph	2	8
8	Conveyor No. 3	48" belt	300 tph	2	8
9	Crusher Tower	N/A	150 tph	2	8
10	Coal Surge Bin w/ Vent Filter	Compartment	200 ton	4	16
12	As-Fired Coal Sampling System	Swing hammer		2	8
13	Conveyor No. 4	48" belt	200 tph	2	8
14	Coal Silo w/ Vent Filter and Slide Gates	N/A	2,500 ton	2	8

ACCOUNT 2 COAL PREPARATION AND FEED**ACCOUNT 2A FUEL SLURRY PREPARATION AND FUEL INJECTION**

Equipment No.	Description	Type	Design Condition	Qty	Total Plant
1	Vibratory Feeder		300 tph	2	8
2	Conveyor No. 1	Belt	300 tph	2	8
3	Conveyor No. 2	Belt	300 tph	2	8
4	Rod Mill Feed Hopper	Vertical, double hopper	200 tons	2	8
5	Vibratory Feeder		100 tph	4	16
6	Weight Feeder	Belt	100 tph	4	16
7	Rod Mill	Rotary	100 tph	4	16
8	Slurry Water Storage Tank with Agitator	Field erected	100,000 gal	4	16
9	Slurry Water Pumps	Horizontal, centrifugal	1,200 gpm	4	16
10	Rod Mill Product Tank with Agitator	Field erected	100,000 gal	4	16
11	Rod Mill Product Pumps	Horizontal, centrifugal	1,000 gpm	4	16
12	Slurry Storage Tank with Agitator	Field erected	350,000 gal	2	8
13	Centrifugal Slurry Pumps	Horizontal, centrifugal	3,000 gpm	4	16
14	PD Slurry Pumps	Progressing cavity	500 gpm	4	16
15	Slurry Blending Tank with Agitator	Field erected	100,000 gal	2	8
16	Slurry Blending Tank Pumps	Horizontal, centrifugal	200 gpm	4	16

**ACCOUNT 3 FEEDWATER AND MISCELLANEOUS SYSTEMS AND
EQUIPMENT**

ACCOUNT 3A CONDENSATE AND FEEDWATER SYSTEM

Equipment No.	Description	Type	Design Condition	Qty	Total Plant
1	Cond. Storage Tank	Vertical, cylindrical, outdoor	50,000 gal	1	4
2	Condensate Pumps	Vert. canned	1,500 gpm @ 400 ft	2	8
3	Deaerator (integral with HRSG)	Horiz. spray type	700,000 lb/h 200°F to 240°F	2	8
4	LP Feed Pump	Horiz. centrifugal single stage	300 gpm/1,000 ft	2	8
5	HP Feed Pump	Barrel type, multi-staged, centr.	1,500 gpm @ 5,500 ft & 600 gpm @ 1,700 ft	2	8

ACCOUNT 3B MISCELLANEOUS EQUIPMENT

Equipment No.	Description	Type	Design Condition	Qty	Total Plant
1	Auxiliary Boiler	Shop fabricated, water tube	400 psig, 650°F 70,000 lb/h	1	4
2	Service Air Compressors	Recip., single stage, double acting, horiz.	100 psig, 750 cfm	1	4
3	Inst. Air Dryers	Duplex, regenerative	750 cfm	1	4
4	Service Water Pumps	Horiz. centrifugal, double suction	200 ft, 1,200 gpm	2	8
5	Closed Cycle Cooling Water Pumps	Horizontal, centrifugal	70 ft, 500 gpm	1	4
6	Fire Service Booster Pump	Two-stage horiz. Centrifugal	250 ft, 1,200 gpm	1	4
7	Engine-Driven Fire Pump	Vertical turbine, diesel engine	350 ft, 1,000 gpm	1	4
8	Raw Water Pumps	SS, single suction	60 ft, 300 gpm	1	4
9	Filtered Water Pumps	SS, single suction	160 ft, 120 gpm	1	4
10	Filtered Water Tank	Vertical, cylindrical	15,000 gal	1	4
11	Makeup Demineralizer	Anion, cation, and mixed bed	70 gpm	1	4
12	Sour Water Stripper System	Vendor supplied	50,000 lb/h sour water	1	4
13	Liquid Waste Treatment System	Vendor supplied	200 gpm	1	4

ACCOUNT 4 GASIFIER AND ACCESSORIES**ACCOUNT 4A GASIFICATION**

Equipment No.	Description	Type	Design Condition	Qty	Total Plant
1	Gasifier and Associated Equipment	Pressurized two-stage slurry-feed, entrained bed	2,726 dry ton/day, 450 psia	2	8
2	Syngas Cooler	Vertical Downflow Fire Tube Heat Exchanger	600,000 lb/hr syngas	2	8
3	Syngas Scrubber	Vertical, upflow	600,000 lb/h	2	8
4	Flare Stack	Self-supporting, carbon steel, stainless steel top, pilot ignition	600,000 lb/h, medium-Btu gas	2	8

ACCOUNT 4B AIR SEPARATION PLANT

Equipment No.	Description	Type	Design Condition	Qty	Total Plant
1	Air Compressor	Centrifugal, multi-stage	100,000 scfm, 199 psia discharge pressure	4	16
2	Cold Box	Vendor Design	2,600 ton/day O ₂	2	8
3	Oxygen Compressor	Centrifugal, multi-stage	40,000 scfm, 500 psia discharge pressure	2	8
4	Nitrogen Compressor	Centrifugal, multi-stage	50,000 scfm, 350 psia discharge pressure	2	8

ACCOUNT 5 SYNGAS CLEANUP

Equipment No.	Description	Type	Design Condition	Qty	Total Plant
1	COS Hydrolysis Reactor	Packed bed	750 psia, 410°F	2	8
2	Mercury Removal	Sulfated Carbon Bed	500,000 lb/hr syngas, 750 psia	2	8
3	Selexol H ₂ S Absorber	Packed bed	8.5 ft OD x 104 ft	2	8
4	CO ₂ Absorber	Packed bed	10 ft OD x 110 ft	4	16
5	Acid Gas Stripper	Packed bed	8.5 ft OD x 96 ft	2	8
6	Lean/Rich Exchanger	Shell & tube	140 x 10 ⁶ Btu/h (total)	2	8
7	Stripper Reboiler	Shell & tube	40 x 10 ⁶ Btu/h	2	8
8	Flash Vessels	22-300 psia	7 ft OD x 40 ft	3	12
9	Lean Pump	Horizontal, centrifugal	3,000 gpm 1,000 hp	2	8
10	Rich Pump	Horizontal, centrifugal	2,000 gpm 100 hp	2	8
11	Syngas Expansion Turbine-Generator	RotoFlow	450,000 lb/hr 6,000 kW	2	8
12	Sulfur Plant	Claus Plant	137 long ton/day (153 ton/day)	1	4
13	CO ₂ Compression	Integrally geared, multi-stage centrifugal; Dehydrated and Intercooled	40,000 scfm, 2,200 psia discharge	1	4

ACCOUNT 5B FISCHER-TROPSCH PROCESS

Equipment No.	Description	Type	Design Condition	Qty	Total Plant
1	Sulfur Polisher	ZnO Packed Bed	400,000 lb/hr Syngas 350 psia	2	8
2	F-T Synthesis Reactors	Slurry Reactors	250,000 lb/hr Syngas, 360 psia, 5,000 BPD	N/A	10
3	CO ₂ Removal Process	Proprietary Amine	2,000 TPD CO ₂	N/A	10
4	CO ₂ Compression	Integrally geared, multi-stage centrifugal; Dehydrated and Intercooled	40,000 scfm, 2,200 psia discharge	N/A	6
5	Hydrocarbon Recovery	Fractionator	100,000 lb/hr	N/A	10
6	Hydrogen Recovery	PSA	700 lb/hr H ₂	N/A	10
7	Recycle Compressor	Reciprocal	60,000 lb/hr	N/A	10
8	Autothermal Reactor	Self-heating Catalytic	60,000 lb/hr	N/A	10
9	Naphtha Hydrotreating	Catalytic Bed	113,000 lb/hr	N/A	1
10	Distillate Hydrotreating	Catalytic Bed	105,000 lb/hr	N/A	1
11	Wax Hydrotreating	Catalytic bed	322,000 lb/hr	N/A	1

ACCOUNT 6

COMBUSTION TURBINE AND AUXILIARIES

Equipment No.	Description	Type	Design Condition	Qty	Total Plant
1	85 MWe Gas Turbine Generator	Axial flow, single spool based on GE PG6111FA	2200°F rotor inlet temp.; 15.7:1 pressure ratio, 449 lb/sec	N/A	3
2	Enclosure	Sound attenuating	85 dB at 3 ft	N/A	3
3	Air Inlet Filter/Silencer	Two-stage	3.0 in. H ₂ O pressure drop, dirty	N/A	3
4	Starting Package	Electric motor, torque converter drive, turning gear	500 hp, time from turning gear to full load ~30 minutes	N/A	3
5	Mechanical Package	CS oil reservoir and pumps dual vertical cartridge filters air compressor		N/A	3
6	Oil Cooler	Air-cooled, fin fan		N/A	3
7	Electrical Control Package	Distributed control system	1 sec. update time 8 MHz clock speed	N/A	3
8	Generator Glycol Cooler	Air-cooled, fin fan		N/A	3
9	Compressor Wash Skid			N/A	3

ACCOUNT 7 WASTE HEAT BOILER, DUCTING, AND STACK

Equipment No.	Description	Type	Design Condition	Qty	Total Plant
1	Heat Recovery Steam Generator	Drum, multi-pressure, with economizer section and integral deaerator	HP-1015 psia/ 1000°F 100,000 lb/h IP-385 psia/1000°F 100,000 lb/h	N/A	3
2	Stack	Carbon steel plate, type 409 stainless steel liner	125 ft high x 8 ft dia.	N/A	3

ACCOUNT 8 STEAM TURBINE GENERATOR AND AUXILIARIES

Equipment No.	Description	Type	Design Condition	Qty	Total Plant
1	100 MW Steam Turbine Generator	Multi-pressure	1000 psig 1000°F/1000°F	1	4
2	Bearing Lube Oil Coolers	Plate and frame		2	8
3	Bearing Lube Oil Conditioner	Pressure filter closed loop		1	4
4	Control System	Digital electro-hydraulic	1000 psig	1	4
5	Generator Coolers	Plate and frame		2	8
6	Hydrogen Seal Oil System	Closed loop		1	4
7	Surface Condenser	Single pass, divided waterbox	100,000 lb/h steam @ 2.4 in. Hga	1	4

ACCOUNT 9 COOLING WATER SYSTEM

Equipment No.	Description	Type	Design Condition	Qty	Total Plant
1	Circ. Water Pumps	Vertical wet pit	50,000 gpm @ 60 ft	2	8
2	Cooling Tower	Evaporative, mechanical draft, multi-cell	52°F WB/74°F CWT/ 94° HWT	N/A	1

ACCOUNT 10 SLAG RECOVERY AND HANDLING

Equipment No.	Description	Type	Design Condition	Qty	Total Plant
1	Slag Quench Tank	Water bath	15 tph	2	8
2	Slag Crusher	Roll	15 tph	2	8
3	Slag Depressurizer	Proprietary	15 tph	2	8
4	Slag Handling Tank	Horizontal, weir	8 tph	4	16
5	Slag Conveyor	Drag chain	8 tph	4	16
6	Slag Separation Screen	Vibrating	15 tph	2	8
7	Coarse Slag Conveyor	Belt/bucket	15 tph	2	8
8	Fine Ash Storage Tank	Vertical	10,000 gallons	2	8
9	Fine Ash Transfer Pumps	Horizontal/centrifugal	50 gpm	4	16
10	Storage Bin	Vertical	1,000 tons	2	8
11	Unloading Equipment	Telescoping chute	25 tph	2	8

APPENDIX B FINANCIAL MODEL ENTRIES

Financial Model Entries—Plant Inputs

Project Name	Act 1 Large Scale F-T
Project Location	Illinois
Primary Output/Plant Application (Options: Power, Multiple Outputs)	Multiple Outputs
Primary Fuel Type (Options: Gas, Coal, Petroleum Coke, Other/Waste)	Coal
Secondary Fuel Type (Options: None, Gas, Coal, Petroleum Coke, Other/Waste)	None
Plant Output and Operating Data : Note - All ton units are US Short Tons (2000 lbs)	
Syngas Capacity (MMcf/Day)	0
Gross Electric Power Capacity (MW)	652
Net Electric Power Capacity (MW)	124
Steam Capacity (Tons/Hr)	0
Hydrogen Capacity (MMcf/Day)	0
Carbon Dioxide Capacity (MMcf/Day)	560
Elemental Sulfur Capacity (Tons/Day)	612
Slag Ash Capacity (Tons/Day)	2,470
F-T Naphtha (Bbls/Day)	22,173
F-T Diesel (Bbls/Day)	27,819
Environmental Credit (Tons/Day)	0
Overall Capacity Factor (includes planned and unplanned outages)	85%
<i>Enter One of the Following Items(For Each Primary/Secondary Fuel) Depending on Project Type:</i>	
Primary Fuel Heat Rate (Btu/kWh) based on HHV FOR POWER PROJECTS	
Secondary Fuel Heat Rate (Btu/kWh) based on HHV FOR POWER PROJECTS	
Primary Fuel Annual Fuel Consumption (Tons/Day) FOR NON POWER PROJECTS	24,533
Secondary Fuel Annual Fuel Consumption (in Tons/Day) FOR NON POWER PROJECTS	
Initial Capital and Financing Costs (enter 'Additional Costs' in thousand dollars)	
EPC (in thousand dollars)	2,807,224
Owner's Contingency (% of EPC Costs)	26%
Process Contingency (% of Tech. Uncertain EPC Costs)	25%

Portion of Plant that is Technologically Uncertain	16%
Start-up (% of EPC Costs)	2%
Owner's Cost (in thousand dollars)	280,722
Operating Costs and Expenses	
Variable O&M (Thousand Dollars)	\$64,374
Fixed O&M Cost (Thousand Dollars)	\$149,271

Financial Model Entries—Scenario Inputs

(Note: Entries unchanged between cases)

Capital Structure		
Percentage Debt	55%	
Percentage Equity	45%	
Project Debt Terms		
Loan 1: Senior Debt		
% of Total Project Debt (total for Loans 1,2, and 3 must = 100%)	100%	
Interest Rate	8%	
Financing Fee	3%	
Repayment Term (in Years)	15	
Grace Period on Principal Repayment	1	
First Year of Principal Repayment	2012	
Loan Covenant Assumptions		
Interest Rate for Debt Reserve Fund (DRF)	4%	
Debt Reserve Fund Used on Senior Debt (Options: Yes or No)	No	
Depreciation : "SL" for Straight-Line OR "DB" for 150% Declining Balance		Method
Construction (Years) : Note - DB Method Must be 15 or 20 years	15	SL
Financing (Years) : Note - DB Method Must be 15 or 20 years	15	SL
Working Capital		
Days Receivable	30	

Days Payable	30	
Annual Operating Cash (Thousand \$)	\$100	
Initial Working Capital (% of first year revenues)	7%	
ECONOMIC ASSUMPTIONS		
Cash Flow Analysis Period		
Plant Economic Life/Concession Length (in Years)	30	
Discount Rate	12%	
Escalation Factors		
<i>Project Output/Tariff</i>		
Electricity Energy Payment	3.0%	
F-T Liquids	3.0%	
Elemental Sulfur	3.0%	
Slag Ash	3.0%	
<i>Fuel/Feedstock</i>		
Coal	2.0%	
<i>Operating Expenses and Construction Items</i>		
Variable O&M	2.0%	
Fixed O&M	2.0%	
Other Non-fuel Expenses	2.0%	
EPC Costs	2.0%	
Tax Assumptions		
Tax Holiday (in Years)	0	
Income Tax Rate	40%	
Subsidized Tax Rate (used as investment incentive)	0%	(set to 20% in ITC)
Length of Subsidized Tax Period (in Years)	0	(set to 130,000 in ITC)

FUEL/FEEDSTOCK ASSUMPTIONS				
Fuel Prices : For the Base Year, then escalated by fuel factors above				
Coal (\$/US Short Ton)	36.63			
Alternatively, use Forecasted Prices (From Fuel Forecasts Sheet)? (Yes/No)	No			
TARIFF ASSUMPTIONS				
INITIAL TARIFF LEVEL (In Dollars in the first year of construction)				
Electricity Payment (\$/MWh)	\$52			
F-T Naphtha (\$/Barrel)	\$63.00	\$1.50	\$/gallon	
F-T Diesel (\$/Barrel)	\$82.32	\$1.96	\$/gallon	
Elemental Sulfur (\$/US Short Ton)	\$10			
Carbon Dioxide (\$/MSCF)	\$0			
Slag Ash (\$/US Short Ton)	\$0			
CONSTRUCTION ASSUMPTIONS				
Construction Schedule	A	Base Year =	2007	
Construction Start Date	1/1/2007			
Construction Period (in months)	48			
Plant Start-up Date (<i>must start on January 1</i>)	1/1/2011			
EPC Cost Escalation in Effect? (Yes/No)	No			
Percentage of Cost for Construction Periods		Four Year Period		
Enter for Five, Four or Three Year Periods (To the Right --->)		Year 1	Year 2	Year 3
Capital Costs : Unescalated Allocations	15.0%	30.0%	30.0%	25.0%
Initial Working Capital	0.0%	0.0%	0.0%	100.0%
Owner's Contingency (% of EPC Costs)	0.0%	0.0%	0.0%	100.0%
Development Fee (% of EPC Costs)	35.0%	35.0%	30.0%	0.0%
Start-up (% of EPC Costs)	0.0%	30.0%	70.0%	0.0%

Initial Debt Reserve Fund	0.0%	30.0%	70.0%	0.0%
Owner's Cost (in thousand dollars)	0.0%	30.0%	70.0%	0.0%
Interest During Construction	0.0%	30.0%	70.0%	0.0%
Financing Fee	0.0%	30.0%	70.0%	0.0%
Plant Ramp-up Option (Yes or No)	Yes			
Start-Up Operations Assumptions (% of Full Capacity)				
Year 1, First Quarter	75%			
Year 1, Second Quarter	75%			
Year 1, Third Quarter	75%			
Year 1, Fourth Quarter	75%			
<i>Year 1 Average Capacity %</i>	74%			
Year 2, First Quarter	85%			
Year 2, Second Quarter	85%			
Year 2, Third Quarter	85%			
Year 2, Fourth Quarter	85%			
<i>Year 2 Average Capacity %</i>	85%			